

BIC GRAPHIC

Service leader in imprinted writing instruments, paper products and lighters





FREE 48-Hour Production Service!

BIC Graphic makes it easier than ever to GET IT NOW!

Available on Writing Instruments, Sticky Notes, Lighters, Cases and Notebooks.

Please look for the 48 hour production service icon  on the product pages

Program Requirements

Available Personalization Methods

Writing instruments

1 colour imprint on the barrel (For metal products only Laser engraving available)

Sticky Note

4-colour process imprint (25 or 50 sheet)

Lighters

1 colour imprint

Cases

1 colour imprint

Notebooks

1 colour imprint (Screen Printing available on BIC® Notebooks Plastic Cover)

4-colour process imprint (available on BIC® Chipboard Cover 4-Colours)

Imprint position

1 standard position

Maximum Quantity

Price List End Column Quantity

Mini and Medium Sticky Note available up to 1.000 units

Notebooks available up to 250 units

Order and Art E-mail

48H must be included in the subject of the e-mail

For online orders: 48H must be included in the key word

Eligible Countries

European Union, Switzerland and Norway

Promotion Code

48 H - MUST be referenced when ordering

Additional Program Details:

In the event that we are out-of-stock on the item you ordered, we will offer you an alternative item



Order Requirements

- Complete order and electronic or production-ready artwork must be received by BIC Graphic Europe by 12:00 p.m. GMT+1, Monday to Friday. Artwork requiring customer approval must be approved by 2:00 p.m. GMT+1.
- Weekends and local Spanish holidays are not considered as working days.

Shipping

- BIC Graphic cannot guarantee a delivery date.

Other

- BIC® Pencils available only cut end and unsharpened.
- Artwork Changes - Please allow additional time for artwork adjustments.
- Accounts on credit hold are not eligible.
- BIC Graphic cannot guarantee 48 Hour Production Service in case of event outside of BIC's reasonable control.

www.bicgraphic.com



A message from our Chairman

2011 is a year to celebrate! We are proudly commemorating the 10th anniversary of the introduction of the BIC® Media Clic pen in Europe. The BIC® Media Clic continues to be a best seller, with timeless styling, unsurpassed quality and advertising impact. I would like to personally thank all of our loyal customers for your continued support over the years.

As we honor the past, we also continue to invent the future, focusing on service leadership and our core product competencies. You will notice the 2011 BIC Graphic catalogue features BIC® Writing Instruments, BIC® Sticky Note, BIC® Lighters and BIC® Notebooks. FREE 48-Hour production service is also available on the majority of our products, perfect for last minute orders, there when you need it.

Inventing the future also means protecting our environment for future generations. BIC's approach to sustainable development minimizes environmental impact. Designs are simple and functional, containing only essential components. In addition, many of our items are refillable, which gives you the ability to use them over and over again. Today, BIC Graphic is proud to offer a wide range of writing instruments, paper products and packaging manufactured with recycled material or renewable resources.

Simplicity is a BIC cornerstone. The BIC Advantage offers free imprint colour changes, production art, virtual samples and more. Product safety is another core value of our company. Every BIC® product undergoes compliance testing for all relevant regulations and standards before it is placed on the market. BIC makes it simple to order and assures confidence in the products carrying your company imprint!

For over 40 years, the BIC® name has stood for superior quality, affordability, safety and service. We will continue this commitment to you, our valued customers, and look forward to the years to come.



Bruno Bich
Chairman



Un Message de notre Président

2011, une année de célébration! Nous commémorons avec fierté le 10^e anniversaire de l'introduction du stylo BIC® Media Clic en Europe. Le BIC® Media Clic figure toujours parmi les meilleures ventes, avec un style intemporel, une qualité inégalable, et un vrai impact publicitaire. Je souhaite remercier personnellement tous nos clients fidèles pour leur soutien au fil des ans.

Tout en honorant le passé, nous continuons à inventer l'avenir, en nous concentrant sur notre capacité à proposer le meilleur service et sur nos compétences produites. Vous remarquerez que le catalogue BIC Graphic 2011 présente les BIC® Writing Instruments, BIC® Sticky Note, BIC® Lighters et BIC® Notebooks. Un service de production GRATUIT 48 heures est également disponible sur la majorité de nos produits, parfait pour les commandes de dernière minute, là où vous en avez besoin.

Inventer l'avenir veut aussi dire protéger notre environnement pour les générations futures. L'approche de BIC vis-à-vis du développement durable minimise l'impact sur l'environnement. De plus, un grand nombre de nos articles sont rechargeables, ce qui vous permet de les utiliser encore et encore. Aujourd'hui, BIC Graphic est fier de proposer une vaste gamme d'instruments d'écriture, de produits papier, et d'emballages, fabriqués avec des matériaux recyclables ou des ressources renouvelables.

La simplicité est une pierre angulaire de BIC. Le programme BIC Advantage propose des changements de couleur d'impression gratuits, de la production haut de gamme, des échantillons virtuels, et plus encore. La sécurité de nos produits est une autre valeur centrale de notre société. Chaque produit BIC® subit des tests pour vérifier sa conformité par rapport aux réglementations et aux standards en matière de sécurité avant d'être mis sur le marché. BIC vous permet de commander facilement et vous assure un support de qualité pour développer l'image de votre société.

Depuis plus de 40 ans, la marque BIC® incarne la qualité, l'accessibilité, la sécurité, et le service. Nous allons continuer à respecter cet engagement envers vous, nos chers clients, et nous réjouissons d'avance pour les années à venir.

Sincèrement,
Bruno Bich

Mensaje de nuestro Presidente

¡2011 es un año de celebraciones! Estamos orgullosos de conmemorar el 10^o aniversario de la presentación del bolígrafo BIC® Media Clic en Europa. El BIC® Media Clic sigue siendo uno de los productos mejor vendidos, con un diseño atemporal, una calidad sin igual y un gran impacto publicitario. Me gustaría dar las gracias personalmente a todos nuestros leales clientes por su respaldo continuado a lo largo de los años.

A la vez que honramos el pasado, seguimos inventando el futuro, centrándonos en el liderazgo de servicio y en nuestras competencias fundamentales de producto. Se habrá dado cuenta de que el catálogo 2011 BIC Graphic presenta las siguientes categorías: BIC® Writing Instruments, BIC® Sticky Note, BIC® Lighters y BIC® Notebooks. La mayoría de nuestros productos cuentan con un servicio de producción GRATIS de 48 horas, ideal para los pedidos del último momento, siempre que lo necesite.

Inventar el futuro también significa proteger el medioambiente para las generaciones futuras. El enfoque de BIC hacia el desarrollo sostenible minimiza el impacto medioambiental. Los diseños son simples y funcionales, y contienen sólo los componentes esenciales. Además, muchos de nuestros artículos son recargables, lo que le da la oportunidad de usarlos una y otra vez. Hoy, BIC Graphic está orgulloso de ofrecer una amplia gama de instrumentos de escritura, productos de papelería y envoltorios fabricados con material reciclable o recursos renovables.

La simplicidad es una piedra angular de BIC. El programa BIC Advantage ofrece de forma gratuita cambios de color, artes finales, muestras virtuales, etc. La seguridad del producto es otro valor esencial de nuestra empresa. Todo producto BIC® está sujeto a una prueba de conformidad para todas las disposiciones y normas relevantes antes de comercializarlo. ¡BIC hace que sea muy sencillo pedir y garantiza la calidad de los productos que llevan su marca de empresa con toda confianza!

Durante más de 40 años el nombre BIC® ha sido sinónimo de calidad superior, precio asequible, seguridad y servicio. Mantendremos este compromiso con Ud., nuestro apreciado cliente, y así seguiremos los años venideros.

Sinceramente,
Bruno Bich

Sehr geehrter Geschäftspartner

2011 ist ein Jahr zum Feiern! Wir begehen mit Stolz den 10. Jahrestag der Markteinführung des BIC® Media Clic Stiftes in Europa. Der BIC® Media Clic ist nach wie vor ein Bestseller mit zeitlosem Styling, unübertroffener Qualität und großer Werbewirkung. Ich möchte gern all unseren treuen Kunden persönlich für Ihre kontinuierliche Unterstützung über die Jahre hinweg danken.

Während wir auf die Vergangenheit zurückblicken, gestalten wir auch weiterhin die Zukunft und konzentrieren uns auf unsere Führungsrolle beim Service und unseren Kompetenzen bezüglich unserer Kernprodukte. Sie werden sehen, dass der BIC-Graphic-Katalog für 2011 BIC® Writing Instruments, BIC® Sticky Note, BIC® Lighters und BIC® Notebooks.

Für die Mehrzahl unserer Produkte steht Ihnen auch ein 48-Stunden-Service zur Verfügung, der für Bestellungen in letzter Minute perfekt ist – stets verfügbar, wenn Sie ihn brauchen.

Die Zukunft zu gestalten bedeutet auch, unsere Umwelt für künftige Generationen zu schützen. BICs Ansatz zu einer nachhaltigen Entwicklung minimiert die Auswirkung auf die Umwelt. Die Designs sind einfach und zweckmäßig, nur die wesentlichen Komponenten enthaltend. Darüber hinaus sind viele unserer Artikel nachfüllbar, was Ihnen die Möglichkeit gibt, sie immer wieder zu benutzen. BIC Graphic ist heute stolz darauf, eine breite Palette von Schreibgeräten, Papierprodukten und Verpackungen anzubieten, die aus wiederverwerteten Materialien oder erneuerbaren Ressourcen bestehen.

Schlichtheit ist ein Eckpfeiler von BIC. Die BIC-Advantage bietet kostenlose Farbänderungen von Aufdrucken, production art, virtuelle Muster und vieles mehr. Produktsicherheit ist ein weiterer Grundwert unseres Unternehmens. Jedes BIC®-Produkt wird einem Compliance-Test für sämtliche relevanten Vorschriften und Normen unterzogen, bevor es auf den Markt gelangt. BIC macht das Bestellen leicht und sichert das Vertrauen in die Produkte, die Ihren Firmenaufdruck tragen!

Seit mehr als 40 Jahren steht der Name BIC® für überlegene Qualität, Erschwinglichkeit, Sicherheit und Service. Wir werden diese Verpflichtung Ihnen, unseren geschätzten Kunden gegenüber, fortsetzen und sehen den kommenden Jahren mit Zuversicht entgegen.

Herzlichst Ihr,
Bruno Bich

Un messaggio dal nostro Presidente

Il 2011 è un anno da festeggiare! Siamo orgogliosi di celebrare il 10^o anniversario della commercializzazione della penna BIC® Media Clic in Europa. BIC® Media Clic continua ad essere un best seller, con uno stile senza tempo, una qualità senza rivali e con un forte impatto pubblicitario. Gradirei ringraziare personalmente tutti i nostri clienti fedeli per il loro continuo supporto nel corso degli anni.

Oltre ad onorare il passato, continuiamo anche ad inventare il futuro, concentrandoci sulla leadership nell'assistenza e sulle competenze nei nostri prodotti di base. Noterete che il catalogo BIC Graphic 2011 presenta BIC® Writing Instruments, BIC® Sticky Note, BIC® Lighters e BIC® Notebooks. Il servizio GRATUITO di produzione in 48 ore è oggi disponibile per gran parte dei nostri prodotti a catalogo, l'ideale per gli ordini last minute.

Inventare il futuro significa anche proteggere il nostro ambiente per le generazioni future. L'approccio BIC in materia di sviluppo sostenibile riduce al minimo l'impatto ambientale. I design sono semplici e funzionali, e contengono solo i componenti essenziali. Inoltre, molti dei nostri prodotti sono ricaricabili, per offrirvi l'opportunità di usarli per molto tempo ancora. Oggi, BIC Graphic è orgogliosa di offrire una vasta gamma di strumenti di scrittura, prodotti cartacei ed i imballi prodotti con materiale riciclato o risorse rinnovabili.

La semplicità è un caposaldo di BIC. Il BIC Advantage offre modifiche gratuite del colore di stampa, arte della produzione, campionature virtuali e altro ancora. La sicurezza del prodotto è un altro valore basilare della nostra azienda. Ogni prodotto BIC® viene sottoposto a test di conformità per tutte le direttive e gli standard rilevanti prima di essere messo sul mercato. BIC rende semplice fare gli ordini ed assicura fiducia nei prodotti che riportano il logo della vostra società!

Per oltre 40 anni, il nome BIC® ha significato qualità superiore, accessibilità, sicurezza e servizio. Continueremo a mantenere questi impegni nei vostri confronti, nei confronti dei nostri pregiati clienti, e attendiamo con impazienza gli anni a venire.

Sinceramente,
Bruno Bich

Overview

Easy-to-follow page layout

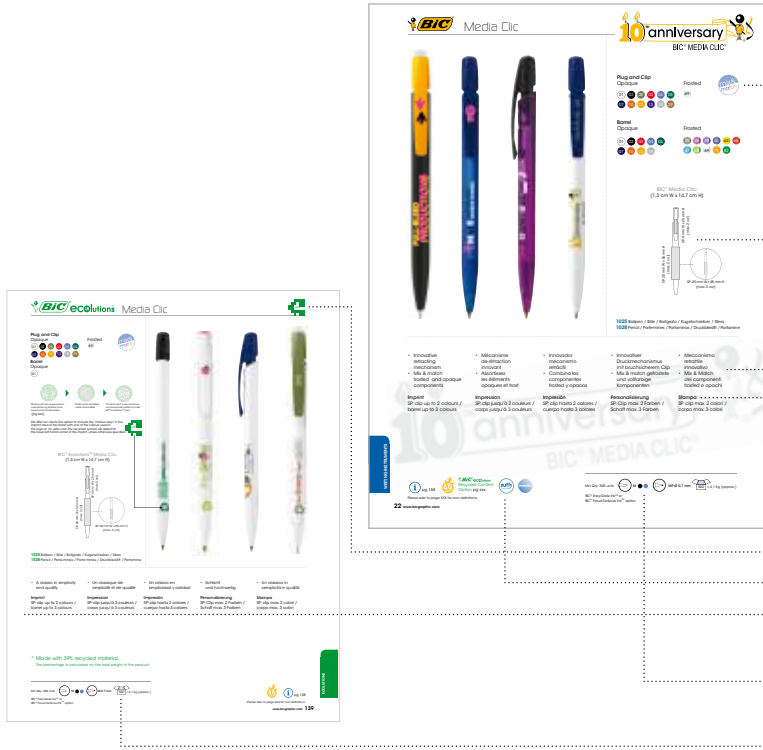

- 1 **Mix & Match**
Offers high colour flexibility when mixing and matching components
- 2 **Imprint area diagrams**
Refer to these diagrams for: Actual product size
Imprint areas, available imprint options and number of imprint colours
- 3 **Features & Benefits**
Bullet points outline key features and benefits for each product
- 4 **Imprint information**
Includes all information related to the imprint - Imprint options are abbreviated (SP, LE, DG...), The number of imprint colours is indicated between ().
- 5 **Icons**
Refer to this area for additional options available on this product as well as where to find general information.
- 6 **Writing modes and ink colours**
Icons refer to available writing modes and ink colours.
- 7 **Language**
Product specific information arranged by language as follows: English, French, Spanish, German and Italian.
- 8 **Möbius loop**
We offer our clients the option to include the "Möbius loop" in the imprint area of the product with one of the colours used in the logo at no extra cost.
- 9 **Packaging & Weights**
Handy icons show quantity per box and approx. weight.

French

- 1 **Mix & Match**
Indique la possibilité d'assortir les composants à votre choix.
- 2 **Shéma de la zone d'impression**
Se référer à ce schéma pour : la zone réelle d'impression du produit, les options d'impression disponibles, et le nombre de couleur d'impression possible.
- 3 **Caractéristiques et Avantages**
Les points clés des caractéristiques et les avantages de chacun des produits.
- 4 **Information sur l'impression**
Inclut toutes les informations relatives à l'impression – l'option d'impression est indiquée par une abréviation (SP, LE, DG...), le nombre de couleur d'impression est indiqué entre ().
- 5 **Symboles**
Se référer à cette zone pour des options additionnelles disponibles pour ce produit ainsi que pour les informations générales.
- 6 **Modes d'écriture et couleur d'encre**
Les symboles font référence aux modes d'écriture et aux couleurs d'encre disponibles.
- 7 **Langues**
Les informations spécifiques du produit sont classées par langue selon cet ordre : Anglais, Français, Espagnol, Allemand et Italien.
- 8 **Boucle de Möbius**
Nous offrons à nos clients la possibilité d'inclure la « boucle de Möbius » dans la zone d'impression du produit dans une des couleurs utilisées pour le marquage sans charge additionnelle.
- 9 **Packaging et Poids**
Le symbole montre la quantité par boîte et le poids approximatif.

Spanish

- 1 **Mix & Match**
Indica gran flexibilidad de colores mezclando y combinando los componentes.
- 2 **Plano de Áreas de Impresión**
Los planos de los productos incluyen: la medida de producto, áreas de impresión, opciones de impresión disponibles y números de colores de impresión.
- 3 **Características y Beneficios**
Destaca las características y beneficios de cada producto.
- 4 **Información de Impresión**
Incluye toda la información relativa a la impresión – las opciones de impresión se indican con abreviaciones (SP: serigrafía, LE: láser, DG: digital...), la cantidad de colores de impresión se indica entre paréntesis ().
- 5 **Iconos**
Se refiere a opciones adicionales disponibles en este producto, además de dónde encontrar información general.
- 6 **Modos de Escritura y Colores de Tinta**
Los iconos se refieren a los modos de escritura y colores de tinta disponibles.
- 7 **Idiomas**
Información técnica de producto. Ordenada por idiomas de la siguiente forma: inglés, francés, español, alemán e italiano.
- 8 **Möbius loop**
Le ofrecemos a nuestros clientes la posibilidad de añadir el "Möbius loop" en el área de impresión del producto utilizando uno de los colores del logo, sin cargo adicional.
- 9 **Envasado y Pesos**
Los iconos muestran la cantidad de producto por caja y peso aproximado.

German

- 1 **Mix & Match**
Bietet höchste Flexibilität bei der Auswahl der Farben für alle Ausstattungs-elemente.
- 2 **Druckflächen-darstellung**
Verweist auf: Tatsächliche Produktmaße; Druckflächen, erhältliche Druckoptionen und Anzahl der Druckfarben.
- 3 **Produkteigenschaften und Merkmale**
Aufzählung der wichtigsten Produkteigenschaften und Merkmale.
- 4 **Druckinformatio**
Beinhaltet alle druckrelevanten Details – eine Abkürzung (SD, LG, DD etc.) gibt die jeweilige Druckoption, die Zahl in Klammern () die Anzahl der Druckfarben an.
- 5 **Symbole**
Verweisen auf zusätzliche Optionen sowie auf weitere allgemeine Informationen über das jeweilige Produkt.
- 6 **Schreibausführungen und -Farben**
Symbole geben die erhältlichen Schreibausführungen und -Farben an.
- 7 **Sprache**
Produktdetails sind in mehrere Sprachen aufgeführt: Englisch, Französisch, Spanisch, Deutsch und Italienisch.
- 8 **Möbius-Schleife**
Die "Möbius-Schleife" kann ohne Aufpreis dem Kundenlogo, in einer der Logofarben, hinzugefügt werden.
- 9 **Verpackungen & Gewicht**
Los iconos Übersichtliche Symbole zeigen die Menge und das ungefähre Gewicht pro Karton.

Italian

- 1 **Mix & Match**
Indica la possibilità di combinare con grande flessibilità i vari particolari del prodotto
- 2 **Diagrammi con area di stampa**
I diagrammi indicano: La dimensione del prodotto Area di stampa, tecniche di decorazione disponibili e numero di colori di stampa possibili
- 3 **Caratteristiche e Benefici del prodotto**
Indica i principali benefici e caratteristiche del prodotto
- 4 **Informazioni di stampa**
Include tutta l'informazione relativa alla stampa – le opzioni di decorazione sono indicate con una abbreviatura (SP, LE, DG...), il numero di colori di stampa possibili è indicato tra parentesi ()
- 5 **Iconi**
Indica le opzioni di decorazione disponibili per un determinato prodotto e dove incontrare informazioni generiche sulla categoria di prodotto
- 6 **Modalità di scrittura e colori di inchiostro**
Le icone indicano le modalità di scrittura e colori di inchiostro disponibili per ciascun prodotto
- 7 **Lingue**
La informazione tecnica del prodotto e" espressa nel seguente ordine: inglese, francese, spagnolo, tedesco ed italiano
- 8 **Möbius loop**
Offriamo ai nostri clienti la possibilità di aggiungere il "Möbius loop" nell'area di stampa del prodotto utilizzando uno dei colori del logo, senza costi supplementari.
- 9 **Packaging e peso**
La icona indica il quantitativo di prodotto contenuto in ciascun cartone e il suo peso approssimativo.

Symbols & Abbreviations

Special Options



Mix & match

Indicates high colour flexibility when mixing and matching components.



Metallic

Upgrade your message with metallic imprint inks at no charge.



Puffy Printing

A highlighted personalisation with our "Puffy" ink.



Digital Transfer

Ideal for reproducing photographs, logos and digital images on lighters.



4-colour process

Allows reproduction of high resolution images. Ideal for reproducing photos. Original and eye-catching.



Digital

High definition 4-colour process. 360 degrees and full length of the barrel.

Writing Modes (See page 48)



M Medium
F Fine

Ballpen



FP

Fountain Pen



HL

Highlighter



MK

Marker



MP ø 0.7 mm

Mechanical Pencil



P

Pencil



R

Roller Ball



G

Gel



FS

Finestyle

● Black Ink

● Blue Ink

● Red Ink

● Green Ink

● Yellow Ink

● Pink Ink

● Orange Ink



BIC® Easy-Glide Ink™



BIC® Fraud Defense Ink™

Other Symbols



48 Hour

48 hour production service available



Mobius Loop

Product contains recycled material. The % of recycled material weight in the product must appear next to or inside the mobius loop. We offer our clients the option to include the "mobius loop" in the imprint area of the product with one of the colours used in the logo at no extra cost. The "mobius loop" will default to the lower left hand corner of the imprint, unless otherwise specified.



xxx = xx Kg (approx.)

Packaging Information



New 2011 products



General Information

Product and Technical Information



Child Resistant

Child Resistant for lighters



New 2011 Colours



Refresh 2011 products

Abbreviations

Min Qty. = Minimum Quantity

SP = Screen Printing

LE = Laser Engraving

4CP = 4-Colour Process

HS = Hot Stamping

DB = Debossing

PD = Pad Printing

DW = Digital Wrap

DT = Digital Transfer

DG = Digital

W x H x D = Width x Height x Depth

Side 1 / Side 2 = Front or back side



Special Options Options Spéciales / Opciones Especiales / Besondere Druckoptionen / Opzioni Speciali

Mix & match

Indique que les couleurs des différents éléments peuvent être mélangées. / Indica la gran flexibilidad de combinar diferentes colores de componentes. / Das Mix & Match-Logo steht für freie Farbauswahl der unterschiedlichen Komponenten. / Indica la possibilità di combinare con grande flessibilità i vari componenti del prodotto

Puffy Printing

Une personnalisation attrayante grâce à notre encre Puffy. / Una atractiva personalización gracias a nuestra tinta Puffy. / Eine ganz besondere Darstellung Ihrer Marke mit unserer Puffy-Relieffinte. / Un'attraente personalizzazione grazie al nostro inchiostro Puffy.

4-colour process

Permet la reproduction d'images de haute résolution. Idéal pour la reproduction de photographies. Original et attrayant. / Permite la reproducción de imágenes de alta resolución. Ideal para la reproducción de fotografías. Original y atractivo. / Aufdruck von Bildern mit hoher Auflösung. Ideal für Fotoaufdrucke. Origineller Blickfang. / Consente la riproduzione di immagini ad alta risoluzione. Ideale per la riproduzione di fotografie. Originale e attraente.

Metallic

Faites ressortir votre message avec une impression à l'encre métallique et sans aucun coût additionnel. / Realce su mensaje imprimiendo con tinta metálica sin ningún coste adicional. / Erhöhen Sie mit Metallicfarben die Wirkung Ihrer Nachricht ohne jeglichen Aufpreis. / Mettete in risalto il vostro messaggio stampando con inchiostro metallizzato senza costi supplementari.

Digital Transfer

Idéal pour reproduire des photographies, logos ou des images digitales sur briquets. / Ideal para reproducir fotografías, logos e imágenes en digital sobre encendedores. / Ideal für Photos, Logos und Digitalzeichnungen. / Ideale per la riproduzione di fotografie, loghi ed immagini digitali sull'accendino.

Digital

Quadrachromie haute définition, à 360 degrés et sur toute la longueur du corps du crayon. / Cuatricromía de alta definición. 360° y toda la longitud del cuerpo. / Hochauflösender 4-Farb-Prozess. 360° Rundumdruck auf dem ganzen Schaft. / Alta definizione - stampa in digitale a 4 colori. 360 gradi su tutta la lunghezza del corpo.

Writing Modes Modes d'écriture / Modos de escritura / Schreibausführungen / Modalità di scrittura (pg 48)

Ballpen / Bille / Bolígrafo / Kugelschreiber / Sfera

Fountain Pen / Stylo Plume / Pluma / Füllfederhalter / Penna Stilografica

Highlighter / Surligneur / Resaltador / Leuchtmarker / Evidenziatore

Marker / Marqueur / Marcador / Permanent Marker / Marcatore

Mechanical Pencil / Mechanical Pencil / Porte-mines /

Porta minas / Druckbleistift / Portamina

Pencil / Crayon / Lápiz / Bleistift / Matita

Roller Ball / Stylo à bille roulante / Roller / Rollerball / Roller

Gel / Gel / Gel / Gelschreiber / Gel

Finestyle / Feutre pointe fine / Escritura fina / Fineliner / Finestyle

Black / Noir / Negro / Schwarz / Nero

Blue / Bleu / Azul / Blau / Azzuro

Red / Rouge / Rojo / Rot / Rosso

Green / Vert / Verde / Grün / Verde

Yellow / Jaune / Amarillo / Gelb / Giallo

Pink / Rose / Rosa / Rosa / Rosa

Orange / Orange / Naranja / Orange / Arancio



BIC® Easy-Glide Ink™



BIC® Fraud Defense Ink™

Other Symbols Autres Symboles / Otros Símbolos / Andere Symbole / Altri Simboli

48 Hour

Service 48 h disponible / Servicio 48 h disponible / 48 Stunden service / Servizio 48 ore disponibile

Möbius Loop

(FRA) Le produit contient des matières recyclées. Le pourcentage du poids de matière recyclée dans le produit doit apparaître à proximité de la boucle de Möbius ou à l'intérieur de celle-ci. Sur demande du client, nous pouvons ajouter la "boucle de Möbius" dans la zone d'impression du corps, dans l'une des couleurs utilisées, sans frais supplémentaire. La boucle de Möbius sera placée, par défaut, en bas à gauche de la zone d'impression, sauf indication contraire. / (ESP) Producto que contiene material reciclado. El porcentaje del peso de material reciclado en el producto debe aparecer al lado o dentro del "Möbius loop". Si el cliente lo desea, podemos añadir el "möbius loop" dentro del área de impresión en uno de los colores ya utilizados, sin cargo alguno. El símbolo de reciclado se colocará en la parte inferior izquierda de la impresión, a menos que se indique lo contrario. / (DEU) Das Produkt enthält recyceltes Material. Der Anteil (%) des recycelten

Materials muss in oder neben der Möbius-Schleife stehen. Auf Kundenwunsch, können wir die "Möbius Schleife" innerhalb der Druckfläche des Gehäuses in einer der für ihr Logo benutzten Farben ohne zusätzliche Kosten hinzufügen. Die Möbius-Schleife wird automatisch im unteren linken Bereich gedruckt, sofern nicht anders angegeben. / (ITA) Indica prodotti contenenti materiale riciclato. La percentuale del peso totale di materiale riciclato deve apparire al lato o dentro del "Möbius loop". Se il cliente lo desidera, è possibile aggiungere il simbolo del "möbius loop" nell'area di stampa del corpo in uno dei colori già utilizzati senza alcun supplemento. Il simbolo "möbius loop" viene stampato automaticamente nell'angolo a sinistra dell'area di stampa, se non diversamente specificato.

Packaging Information

Informations sur l'emballage / Información de envasado / Informationen Verpackungen / Informazioni sul Packaging.

New 2011 products

Nouveaux produits 2011 / Nuevos productos 2011 / Neue Produkte 2011 / Nuovi prodotti 2011.

General Information

Informations sur le produit et informations techniques / Información técnica y de producto / Produkt- und technische Informationen / Prodotti e informazioni tecniche.

Child Resistant

Sécurité-Enfants pour les briquets / Encendedor con seguridad para niños / Kindersicherung für Feuerzeuge / Child resistant per accendini.

New 2011 Colours

Nouveaux coloris 2011 / Nuevos colores 2011 / Neue Farben 2011 / Nuovi colori 2011

Abbreviations Abréviations / Abreviaciones / Abkürzungen / Abbreviature

Minimum Quantity / Quantité minimum / Cantidad mínima / Mindestbestellmenge / Quantità minima

Screen Printing / Sérigraphie / Serigrafía / Siebdruck / Serigrafia

Laser Engraving / Gravure laser / Impresión a láser / Lasergravur / Incisione laser

4-colour Process / Procédé de quadrichromie / Proceso de cuatricromía / 4-Farbdruck / Processo di quadricromia

Hot Stamping / Estampage / Hotstamping / Hotstamping / Stampa a caldo

Debossing / Embossage / Grabado en relieve / Prägung / Bassorilievo

Pad Printing / Tampographie / Tampografía / Tampondruck / Stampa in quadricromia

Digital Wrap / Digital Wrap / Digital Wrap / Wrap-Digitaldruck / Digital Wrap

Digital Transfer / Transfert digital / Transferencia digital / Digitaldruck / Trasferimento digitale

Digital / Digital / Digital / Digital / Digital / Digitale

Width x Height / Largeur x Hauteur / Ancho x Alto / Höhe x Breite / Larghezza x Altezza



The BIC® Advantage

Order Simplicity:

- Virtual Samples!
- Production Art!
- Random Colour Assortments!
- Writing Ink Colour Changes!

FREE!

FREE 48-Hour Production Service!

- Available on selected products of: Writing Instruments, Sticky Note, Notebooks, Lighters, with a multitude of colour and imprint options.



Brand Name Recognition:

- BIC® brand name is recognized by 9 out of 10 people and assures your name will be associated with quality products and services that set industry standards worldwide!



World Class Quality:

- The functionality and reliability of our products is proven by adhering to international quality and product safety standards through the use of top grade materials and cartridges, ensuring the longevity of your message.

Inventory Promise:

- Take advantage of items produced in our factories where stock is ALWAYS available for hundreds of items! If an item is temporarily out of inventory we will offer you a comparable product or upgrade at no additional charge.

Product Innovation:

- Introducing a variety new products in 2011! Look for the "NEW" icon on select product pages.
- Choose from multiple patented designs and products developed by our in-house team of engineers.

Decoration Techniques:

- We strive to provide affordable and revolutionary imprinting processes to enhance your promotion. Choose from over 7 innovative decoration techniques to satisfy your message.

See pages 166-167 for details.



BIC® Wide Body Digital

Mix and Match:

- With up to 400 free standard colour barrel/trim combinations and over 25 free standard imprint colours, you can choose the best colours to complement your logo!



Ink Technology: ● ● ● ● ● ● ●

- Choose from a variety of ink colors and writing modes including our exclusive inks!

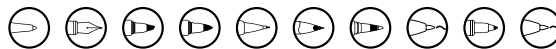

BIC® Easy-Glide System Ink™
Offers 35% smoother and bolder write-out than our current ballpoint.



BIC® Fraud Defense Ink™
Helps prevent check or prescription fraud.

Packaging:

- BIC® Graphic offers you a variety of different packaging options across all categories to make your corporate gifts stand out.



Comanda Simple:

- Maquette Virtuelle!
- Service Graphique!
- Large Gamme de Couleurs!
- Changement de Couleur d'Encre d'écriture!

GRATUIT!

Identification du Nom de Marque:

- Le nom de marque BIC® est reconnu par 9 personnes sur 10 et assure que votre nom sera associé à des produits et services de qualité respectant des standards industriels internationaux!

Stock Disponible:

- Profitez de l'avantage des articles produits dans nos usines où un stock de centaines de produits est TOUJOURS disponible! Si un article est temporairement indisponible nous vous offrons un produit comparable ou bien supérieur sans coût supplémentaire.

Techniques de Personnalisation:

- Nous nous efforçons de fournir des procédés d'impression abordables et révolutionnaires, pour mettre en valeur votre communication. Faites votre choix parmi plus de 7 techniques de personnalisation innovantes pour créer un message qui vous correspond. **Voir pages 166-167 pour les détails.**

Packaging:

- BIC vous propose différentes options de packaging pour l'ensemble des catégories afin de faire ressortir vos cadeaux d'entreprise.

Service Production 48H GRATUIT!

- Disponible pour les Instruments d'écriture, Sticky Note, Notebooks, Briquets, avec une multitude de couleur et d'options d'impression.

Qualité Internationale:

- La fiabilité et la sécurité de nos produits sont prouvés par l'adhésion à des standards internationaux de qualité et de sécurité, et l'utilisation de matériaux et de cartouches de qualité supérieure, assurant la longévité de votre message.

Innovation Produit :

- Introduction de nouveaux produits en 2011! Recherchez l'icône « NEW » sur les pages produits sélectionnées.
- Choisissez parmi une multitude de designs et produits brevetés développés par notre équipe interne d'ingénieurs.

Mix and Match:

- Avec plus de 400 combinaisons corps/attributs en coloris standards sans surcoût et plus de 25 couleurs standards d'impression, vous pouvez choisir les couleurs les plus appropriées en accord avec votre logo!

Techniques d'encres:

- Choisissez parmi une variété de couleurs d'encre et de modes d'écritures incluant nos encres exclusives!

BIC® Easy-Glide System Ink™

Offre une encre qui est 35% plus lisse et plus épaisse que votre stylo à bille actuel.

BIC® Fraud Defense Ink™

Aide à prévenir la fraude des chèques et ordonnances.

Einfaches Bestellwesen:

- Kostenlose Erstellung der Artworks!
- Kostenlose virtuelle Muster!
- Beliebige Farbkombinationen!
- Verschiedene Schreibfarben!

KOSTENLOSER!

Anerkannte Marke:

- Weltweit anerkannter Markenname (9 von 10 befragten Personen kennen BIC). Die Marke BIC® ist Garant, daß auch Ihr Name für führende Qualitätsprodukte und Service steht!

Lagerware:

- Hunderte unserer Produkte sind jederzeit verfügbar, da sie in unseren Produktionsstätten gefertigt werden. Sollte ein Produkt nicht kurzfristig erhältlich sein, bieten wir Ihnen ein vergleichbares oder sogar höherwertiges Produkt ohne Aufpreis an.

Personalisierung:

- Wir bieten Ihnen erschwingliche, revolutionäre Drucktechniken für eine maximale Werbewirkung an. Wählen Sie aus über 7 innovativen Drucktechniken um Ihre Werbebotschaft zu verstärken! **Sieh Seiten 166-167 für Details.**

Verpackungen:

- Die große Auswahl an Verpackungen tragen zusätzlich zur Wirkung Ihrer Werbegeschenke bei.

KOSTENLOSER 48-Stunden Produktionsservice

- Erhältlich für eine große Auswahl an Schreibgeräten, Haftnotizen, Notebooks sowie Feuerzeugen in vielen Farben und mit diversen Personalisierungsmöglichkeiten.

Weltweit anerkannte Qualität:

- Die Funktionalität und Verlässlichkeit unserer Produkte wird durch die Erfüllung internationaler Qualitäts- und Sicherheitsstandards ergänzt; hochwertiger Materialien und Minen sind die Garantie Ihrer unverkennbaren Werbebotschaft.

Produkt Innovationen:

- Wir stellen Ihnen eine Vielzahl neuer Produkte vor. Achten Sie auf das "NEW" Symbol.
- Eine große Auswahl an eigenen und patentierten Designs und Produkten steht Ihnen zur Verfügung.

Mix and Match:

- Wählen Sie passend zu Ihren Firmenfarben und Logo die perfekte Zusammenstellung der Werbepartikel. Wir bieten über 400 kostenfreie Standardfarben (Ausstattungs-elemente/Schaff) und über 25 Standarddruckfarben.

Minen:

- Große Auswahl an Farben, Schreibausführungen und exklusiven Minen.

BIC® Easy-Glide System Ink™

35% weicher und präziser als eine herkömmliche Mine.

BIC® Fraud Defense Ink™

Bietet dauerhaften Schutz gegen Scheckbetrug und Dokumentenfälschung.

Pedidos simples:

- ¡Muestras virtuales!
- ¡Artes gráficas!

GRATIS!

Reconocimiento de Marca:

- La marca BIC® es reconocida por 9 de cada 10 personas y asegura que su nombre estará asociado a productos de calidad y servicios que sobrepasan los estándares del mercado!

Promesa de stock:

- Aproveche nuestros productos, producidos en nuestra fábrica, donde contamos con stock para cientos de referencias. Si un producto se encuentra temporalmente fuera de stock, le ofreceremos un producto similar sin ningún cargo.

Técnicas de Decoración:

- Le proveemos de técnicas de impresión asequibles y revolucionarias para mejorar su promoción. Elija entre nuestras 7 innovadoras técnicas de decoración para conformar su mensaje. **Vea la página 166-167 para los detalles.**

Packaging:

- BIC Graphic le ofrece una variedad de envasados en todas sus categorías para hacer que sus regalos corporativos destaquen.

¡Servicio de Producción

48 hs GRATIS!

- Disponible en productos seleccionados de: Writing Instruments, Sticky Note, Notebooks y Lighters con una multitud de colores y opciones de impresión.

Calidad a nivel mundial:

- La funcionalidad y fiabilidad de nuestros productos es comprobada siguiendo estándares internacionales de calidad y seguridad de los productos. Utilizamos materiales de alta calidad y cartuchos que aseguran la durabilidad de su mensaje.

Innovación de Producto:

- Introducimos una variedad de nuevos productos en 2011. Busque el icono "NEW" en las páginas de producto seleccionadas.
- Elija entre nuestros múltiples diseños patentados y productos desarrollados por nuestro equipo de ingenieros.

Mix & Match:

- Contamos con hasta 400 colores de cuerpo y atributos para combinar y hasta 25 colores de impresión, así podrá escoger el color que complementa mejor su logo!

Tecnología de la tinta:

- ¡Elija entre nuestra variedad de colores de tinta y modos de escritura incluyendo nuestras tintas exclusivas!

BIC® Easy-Glide System Ink™

35% más suave y más fuerte que nuestro bolígrafo actual.

BIC® Fraud Defense Ink™

ayuda a prevenir fraudes en cheques o prescripciones.

Semplicità negli ordini:

- Bozze virtuali!
- Bozze grafiche!
- Una gran varietà di colori!
- Possibilità di cambiare il colore del cartuccino refill!

GRATIS!

Riconoscimento della tua Marca:

- La marca BIC® è riconosciuta da 9 persone su 10, ciò assicura che il tuo nome venga associato a prodotti e servizi di qualità con alti standard industriali!

Inventario Garantito:

- Ci sforziamo di avere prodotti realizzati nelle nostre fabbriche dove gli stock sono SEMPRE disponibili per centinaia di prodotti! Se un prodotto è momentaneamente fuori stock, ti offriremo un prodotto migliore e compatibile senza costi aggiuntivi.

Tecniche di stampa:

- Ci sforziamo di trovare rivoluzionarie e accessibili tecniche di stampa per aumentare la visibilità della tua promozione. Scegli tra più di 7 tecniche di stampa innovative per soddisfare il tuo messaggio. **Vai a pagina 166-167 per i dettagli.**

Packaging:

- BIC ti offre diverse opzioni di packaging per tutte le categorie di prodotti, per rendere i tuoi regali aziendali fuori dagli standard!

Servizio 48 Ore GRATIS!

- Disponibile in strumenti di scrittura, sticky notes e notebook con un'ampia gamma di colori ed opzioni di personalizzazione.

Qualità a livello internazionale:

- La funzionalità e la garanzia dei nostri prodotti è provata dal fatto che aderiamo a standard internazionali di qualità e sicurezza del prodotto grazie all'utilizzo di materiali e refill eccellenti che permetteranno alla sua marca di durare a lungo.

Innovazione Prodotto:

- Nuova varietà di prodotti nel 2011! Cerca l'icône "NEW" nelle pagine prodotto per scoprire quali sono le novità.
- Scegli tra disegni patentati e prodotti disegnati dal nostro team di ingegneri.

Mix & Match:

- Tra più di 400 combinazioni di colore per corpo, clip e cappuccio, potrai scegliere il colore più adatto al tuo logo!

Inchiostri speciali:

- Scegli tra una varietà di inchiostri colorati e metodi di scrittura e refill esclusivi!

BIC® Easy-Glide System Ink™

Offre il 35% di scrittura più fluida e compatta rispetto agli inchiostri standard.

BIC® Fraud Defense Ink™

Preserva dalle frodi su assegni o prescrizioni mediche.

Sustainable Development



A Responsible Promotional Product



In creating its first ballpoint pen, BIC choose to go straight to what is essential by making it simple, putting quality and usability first, and making it affordable for all. Today, "straight to what's essential" is still the BIC promise across all categories and is also reflected in BIC's approach to sustainable development as our products minimize environmental impact.

What's essential is in **good hands**



Today BIC Graphic is proud to offer a range of writing instruments, paper products and packaging manufactured with recycled material or renewable resources.



BIC designs simple, functional products that contains only the essential components.

Our goal is to reduce the amount of raw materials used during production.

Quality equals **longevity**

The use of high grade materials, quality construction and controls ensures the product and your message is long-lasting.



Développement Durable

Aujourd'hui BIC Graphic est fier d'offrir une gamme de produits d'écriture, produits papiers et emballages fabriqués avec des matières recyclées ou des ressources renouvelables.

Un Produit Promotionnel Responsable

En créant son premier stylo à bille, BIC a choisi d'aller à l'essentiel, de manière simple, favorisant en premier la qualité et l'usage et pour un prix abordable pour tous.

Aujourd'hui "aller à l'essentiel" est encore la promesse de BIC au travers de toutes les catégories et est aussi reflété par l'approche BIC sur le développement durable comme nos produits qui minimisent l'impact environnemental.

Ce qui est essentiel est entre de **bonnes mains**

BIC a créé des produits simples, fonctionnels, qui contiennent seulement les composants essentiels.

Notre but est de réduire la quantité des matières premières utilisées durant la production.

Qualité égale **longévité**

L'utilisation de matériaux de classe supérieure, la qualité de la construction et les contrôles assurent au produit et à votre message une longue durée de vie.

Desarrollo Sostenible

Hoy BIC Graphic está orgulloso de ofrecer una gama de productos de escritura, papel y envasados producidos con material reciclado o recursos renovables.

Un producto promocional Responsable

Al crear el primer bolígrafo, BIC eligió ir directo a lo esencial, haciéndolo fácil, anteponiendo la calidad y el uso y haciéndolo asequible para todos.

Hoy "ir directo a lo esencial" sigue siendo la promesa de BIC en todas las categorías y se refleja en también en nuestro acercamiento al desarrollo sostenible ya que nuestros productos minimizan el impacto medioambiental.

Lo esencial está en **buenas manos**

BIC diseña productos simples y funcionales que contienen sólo los componentes esenciales.

Nuestro objetivo es reducir la cantidad de materia prima utilizada durante la producción.

Calidad igual a **larga duración**

La alta calidad en los materiales, la producción y los controles, aseguran que el producto y su mensaje tengan una larga duración.

Nachhaltige Entwicklung

BIC Graphic ist stolz, Ihnen ein breites Sortiment an Schreibgeräten, Papierprodukten und Verpackungen, die aus recycelten Materialien hergestellt werden, anzubieten.

Verantwortungsbewusste Werbeartikel

Mit der Entwicklung des ersten Kugelschreibers, hat BIC sich für den Weg einfache, qualitative und nützliche Produkte zu einem erschwinglichen Preis zu produzieren festgelegt.

BIC steht für "das Wesentliche". Alle von BIC gefertigten Produkte belasten die Umwelt minimal.

Das Wesentliche ist in **guten Händen**

Das einfache und praktische Design aller BIC Produkte beschränkt sich auf ein Minimum an Komponenten. Unser Ziel ist es, die Verwendung von Rohmaterialien für die Produktion zu minimieren.

Qualität = **Langlebigkeit**

Die Verwendung hochwertiger Materialien, die Konstruktion sowie die Kontrollen stellen ein langlebiges Produkt und eine hohe Werbewirksamkeit sicher.

Sviluppo Sostenibile

Oggi Bic Graphic é orgogliosa di offrire un'ampia gamma di prodotti da scrittura, prodotti in carta ed imballaggi realizzati con materiali riciclati.

Un prodotto promozionale responsabile

Lanciando la sua prima sfera al mercato, BIC ha scelto l'essenziale, sviluppando prodotti semplici di qualità ed accessibili a tutti.

Oggi, focalizzarsi solo su ciò che è "essenziale" è ancora la promessa della BIC. Questa promessa riflette il nostro approccio allo sviluppo sostenibile minimizzando l'impatto ambientale.

Ciò che é essenziale é in **buenas manos**

I prodotti BIC hanno un design semplice e funzionale che permette contenere solo componenti essenziali. Il nostro impegno è quello di diminuire la quantità di scarto proveniente dalla produzione.

Qualità significa **longevità**

L'utilizzo di materie prime eccellenti, la qualità nei processi e nei controlli, garantisce che il tuo prodotto ed il tuo messaggio promozionale durino a lungo.



Product Safety

BIC® products comply with U.S., European and International product safety laws and standards

- ✓ All products are reviewed by a **product safety specialist**
- ✓ Includes **tests for lead and other heavy metals**
- ✓ Inks used are assessed by an **independent expert according to European Regulation 1999/45/EC** and are approved by a U.S. toxicologist at Duke University Medical Center
- ✓ All writing instruments meet the **cap and end closure safety standards**



La sécurité des produits

Tous les produits BIC® sont conformes aux lois et standards Européens, Américains et Internationaux sur la sécurité des produits

- ✓ Tous les produits sont revus par un spécialiste en sécurité des produits
- ✓ Tous les produits sont conformes aux diverses exigences applicables au niveau mondial pour les métaux lourds et plomb
- ✓ Les encres utilisées dans tous nos instruments d'écriture sont évaluées par un expert indépendant en accord avec la réglementation Européenne 1999/45/CE et sont revues par un toxicologue américain, Duke University Medical Center
- ✓ Tous les instruments d'écriture sont conformes aux standards sur les capuchons et bouchons

Seguridad de Producto

Todos los productos BIC® cumplen con las leyes y estándares de seguridad de producto tanto europeos como internacionales

- ✓ Todos los productos son revisados por un **especialista en Seguridad de Producto**
- ✓ Incluyendo **testeos de plomo y otros metales pesados**
- ✓ Las tintas utilizadas en nuestros instrumentos de escritura son chequeadas por un experto **independiente de acuerdo con la Regulación Europea 1999/45/EC** y revisadas por el Instituto Toxicológico de Duke University Medical Center (USA)
- ✓ Todos los componentes de nuestros productos de escritura cumplen con las exigencias de seguridad necesarias para **capuchones y botones**

Produktsicherheit

Alle Produkte entsprechen den US, europäischen und internationalen Produktsicherheitsnormen und Standards

- ✓ Alle Produkte werden von **Produktsicherheitsspezialisten** geprüft
- ✓ Alle Produkte **erfüllen die unterschiedlichen, weltweit gültigen, Schwermetallanforderungen**
- ✓ Die Tinten aller Schreibgeräte werden von einem unabhängigen **Experten gemäß der Europäischen Bestimmung 1999/45/EC** bewertet und von einem US Toxikologen, dem Medizinzentrum der Duke Universität, überprüft
- ✓ Alle Schreibgeräte erfüllen die Sicherheitsanforderungen betreffend **Kappe und Endstück**

La sicurezza del prodotto

Tutti i prodotti BIC® soddisfano i parametri di legge e gli standard di sicurezza regolamentati da parametri europei e internazionali

- ✓ Tutti i prodotti sono sottoposti ad una revisione di uno **specialista di sicurezza del prodotto**
- ✓ Tutti i prodotti **soddisfano le richieste di legge in merito al contenuto di metalli pesanti e di piombo**
- ✓ Gli inchiostri dei nostri prodotti da scrittura sono verificati da un **esperto indipendente in accordo con la Regolamentazione Europea 1999/45/EC** e revisionati dall'Istituto Tossicologico della Duke University Medical Center (USA).
- ✓ Tutti i componenti dei nostri prodotti da scrittura soddisfano le esigenze di sicurezza necessarie per **cappucci e pulsanti**

Table of Contents

WRITING INSTRUMENTS 12-63

BIC® SELECT 64-77

SHEAFFER® 78-89

STICKY NOTE 90-109

NOTEBOOKS 110-115

LIGHTERS 116-129





ECOLUTIONS™ 130-151

COMBO & SPECIAL PACKAGING 152-159

GENERAL INFORMATION 160-171



Writing instruments Writing instruments Writing instruments

BIC® Style	14	BIC® Media Max Premium Digital	42
BIC® Style Clear	15	BIC® Atlantis®	43
BIC® Round Stic™	16	BIC® Clic	44
BIC® XS Finestyle & XS Clear Finestyle	17	BIC® Clic Gold	45
BIC® Media Clic	18	BIC® Citation™	46
BIC® Media Clic Grip	19	BIC® Intensity® Gel Clic	47
BIC® Media Clic Grip Digital	20	BIC® 4 Colours & 4 Colours Pen with Lanyard 	48
BIC® Media Clic Premium	21	BIC® Grip Roller	49
BIC® Clic Stic™	22	BIC® Brite Liner® Grip	50
BIC® Soft Feel®	23	BIC® Brite Liner® Grip XL 	51
BIC® Clic Stic™ Grip	24	BIC® Permanent Marker	52
BIC® Clic Stic™ Ice Grip	25	BIC® Mark-it Permanent Marker 	53
BIC® Clic Stic™ Digital	26	BIC® Great Erase White Board Marker 	54
BIC® Clic Stic™ Mini Digital	27	BIC® Matic	55
BIC® Tri Stic™	28	BIC® Matic Quartz	56
BIC® Tri Stic™ Clear	29	BIC® Matic Grip	57
BIC® Vision™ Clic	30	BIC® Clic Matic 	58
BIC® Vision™ Clear	31	What Do You Get for a BIC® ?	59
BIC® Pivo®	32	BIC® Ink Technology.	60
BIC® Wide Body™	33	BIC® Ink Technology.	61
BIC® Wide Body™ Grip	34	BIC® Fraud Defense Ink™	62
BIC® Wide Body™ Clear Grip	35	BIC® Fraud Defense Ink™	63
BIC® Wide Body™ Ice Grip	36		
BIC® Wide Body™ Digital	37		
BIC® Mini Wide Body™ Digital	38		
BIC® Media Max	39		
BIC® Media Max Digital	40		
BIC® Media Max Premium	41		



Writing
instruments

zen
pushi bar



Barrel
Opaque

01

Cap
Opaque

02 03 04 05

Style:
(0,8 cm W x 14,9 cm H)

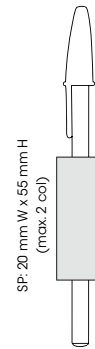

1610 Ballpen/ Bille / Bolígrafo / Kugelschreiber / Sfera

• BIC® designed cap recognized worldwide.

Imprint
SP: barrel up to 2 colours

• Capuchon BIC® reconnu dans le monde entier

Impression
SP: corps jusqu'à 2 couleurs

• Diseño de tapón BIC® reconocido mundialmente

Impresión
SP: cuerpo hasta 2 colores

• BIC® Kugelschreiber mit ikonischer Kappe

Personalisierung
SP: Schaff max. 2 Farben

• Design del cappuccio BIC® riconosciuto in tutto il mondo

Stampa
SP: corpo max. 2 colori



Style Clear

Barrel and Cap
Clear



Style Clear:
(0,8 cm W x 14,9 cm H)

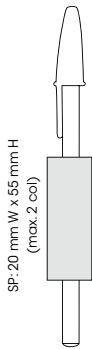

1611 Ballpen/ Bille / Bolígrafo / Kugelschreiber / Sfera

• BIC® designed cap recognized worldwide.

• Capuchon BIC® reconnu dans le monde entier

• Diseño de tapón BIC® reconocido mundialmente

• BIC® Kugelschreiber mit ikonischer Kappe

• Design del cappuccio BIC® riconosciuto in tutto il mondo

Imprint

SP: barrel up to 2 colours

Impression

SP: corps jusqu'à 2 couleurs

Impresión

SP: cuerpo hasta 2 colores

Personalisierung

SP: Schaff max. 2 Farben

Stampa

SP: corpo max. 2 colori

Min Qty: 500 units



M



= 3,5 Kg (approx.)



pg 162

Please refer to page 4 for icon definitions.



Round Stic™



BIC® ROUND STIC®



Cap, Section and Plug

- Opaque
- 01 02 03 04 05
 - 07 10 12 18 20

Frosted

- 40 63 66 67
- 68 69 71



Barrel

- Opaque
- 01 02 03 05 07
 - 12 18

Frosted

- 40 63 66 67
- 68 69 71

BIC® Round Stic™:
(1,2 cm W x 15 cm H)

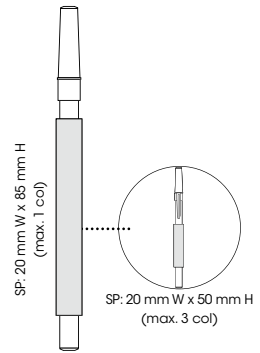

1010 Ballpen / Bille / Bolígrafo / Kugelschreiber / Sfera

• Patented ventilated cap design

• Capuchon ventilé breveté

• Diseño de ventilación del tapón patentado

• Patentiertes Kappendesign

• Design del cappuccio brevettato

Imprint
SP: barrel up to 3 colours

Impression
SP: corps jusqu'à 3 couleurs

Impresión
SP: cuerpo hasta 3 colores

Personalisierung
SP: Schaft max. 3 Farben

Stampa
SP: corpo max. 3 colori





XS Finestyle & XS Clear Finestyle

BIC® XS Finestyle
Barrel and Clip
Opaque

01

BIC® XS Finestyle
Clip
Opaque

01



Trims / Ink
Opaque

03 04

Barrel and Trims / Ink
Clear

40

BIC® XS Finestyle / XS Clear Finestyle:
(1,4 cm W x 12,3 cm H)

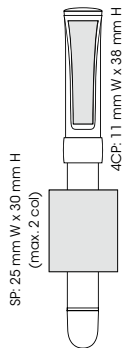

BIC® XS Finestyle

1851 Finestyle / Feutre pointe fine / Escritura fina / Fineliner / Finestyle

BIC® XS Clear Finestyle

1856 Finestyle / Feutre pointe fine / Escritura fina / Fineliner / Finestyle



BIC® XS Finestyle

BIC® XS Clear Finestyle

• Compact size pen
for easy to carry
communication

• Stylo compact , facile
à emporter

• Bolígrafo de tamaño
compacto para una
fácil comunicación

• Kompakter Fineliner
für eine einfache
Kommunikation

• Dimensione compatta
per una comunicazione
maneggevole

Imprint

4CP: clip 4-colour process
SP: barrel up to 2 colours

Impression

4CP: clip quadrichromie
SP: corps jusqu'à 2 couleurs

Impresión

4CP: clip cuatricomía
SP: cuerpo hasta 2 colores

Personalisierung

4CP: Clip 4-Farbdruck
SP: Schaff max. 2 Farben

Stampa

4CP: clip quadricromia
SP: corpo max. 2 colori

Min Qty: 500 units



FS



●



= 2.8 Kg (approx.)



pg 162

Please refer to page 4 for icon definitions.



Plug and Clip
Opaque



Frosted



Barrel
Opaque



Frosted

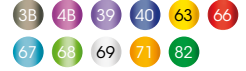

BIC® Media Clic:
(1,3 cm W x 14,7 cm H)

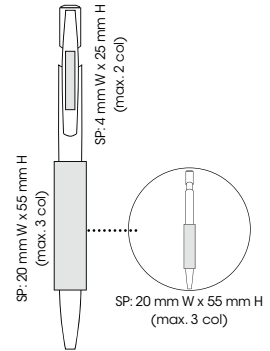

1025 Ballpen / Bille / Bolígrafo / Kugelschreiber / Sfera

1028 Pencil / Porte-mines / Portaminas / Druckbleistift / Portamine

- Innovative retracting mechanism
- Mix & match frosted and opaque components

- Mécanisme de rétraction innovant
- Assortissez les éléments opaques et frost

- Innovador mecanismo retráctil
- Combina los componentes frosted y opacos

- Innovativer Druckmechanismus mit bruchsicherem Clip
- Mix & match gefroste und vollfarbige Komponenten

- Meccanismo retrattile innovativo
- Mix & Match dei componenti frosted e opachi

Imprint
SP: clip up to 2 colours / barrel up to 3 colours

Impression
SP: clip jusqu'à 2 couleurs / corps jusqu'à 3 couleurs

Impresión
SP: clip hasta 2 colores / cuerpo hasta 3 colores

Personalisierung
SP: Clip max. 2 Farben / Schaft max. 3 Farben

Stampa
SP: clip max. 2 colori / corpo max. 3 colori



Media Clic Grip

Plug and Clip Opaque



Frosted

69



Only for plug and clip

Grip Opaque



Barrel Opaque



Grip Frosted



Barrel Frosted



BIC® Media Clic Grip:
(1,3 cm W x 14,7 cm H)

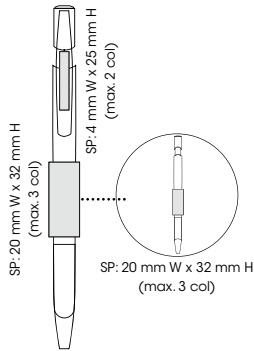

1020 Ballpen / Bille / Bolígrafo / Kugelschreiber / Sfera
1021 Pencil / Porte-mines / Portaminas / Druckbleistift / Portamine

• Comfortable gripping section

• Zone de préhension confortable

• Grip moderno y confortable

• Angenehm weiche Griffzone

• Sezione e grip confortevoli

Imprint

SP: barrel up to 3 colours / clip up to 2 colours

Impression

SP: corps jusqu'à 3 couleurs / clip jusqu'à 2 couleurs

Impresión

SP: cuerpo hasta 3 colores / clip hasta 2 colores

Personalisierung

SP: Schaft max. 3 Farben / Clip max. 2 Farben

Stampa

SP: corpo max. 3 colori / clip max. 2 colori

Min Qty.: 500 units



M



MP

Ø 0,7 mm

BIC® Easy-Glide Ink™ or
BIC® Fraud Defense Ink™ option



500

= 4,3 Kg (approx.)

BIC® eColutions
Recycled Content
Option pg 137



pg 162

Please refer to page 4 for icon definitions.

www.bicgraphic.com 19



Plug and Clip

Opaque



Frosted



Only for plug and clip

Grip

Opaque



Barrel Opaque



BIC® Media Clic Grip Digital:
(1,3 cm W x 14,7 cm H)

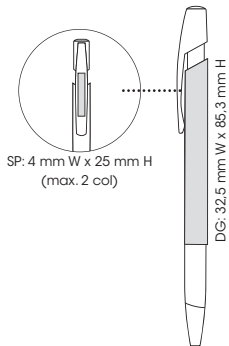

1886 Ballpen / Bille / Bolígrafo / Kugelschreiber / Sfera

1887 Pencil / Porte-mines / Portaminas / Druckbleistift / Portamine

• Comfortable gripping section

• Zone de préhension confortable

• Grip moderno y confortable

• Angenehm weiche Griffzone

• Sezione e grip confortevoli

Imprint

DG: barrel
SP: clip up to 2 colours

Impression

DG: corps
SP: clip jusqu'à 2 couleurs

Impresión

DG: cuerpo
SP: clip hasta 2 colores

Personalisierung

DG: Schaft
SP: Clip max. 2 Farben

Stampa

DG: corpo
SP: clip max. 2 colori





Media Clic Premium

Barrel

4A 5A 6A 7A 8A 9A



Clip

4A 5A

Plug

35

BIC® Media Clic Premium:
(1,3 cm W x 14,7 cm H)

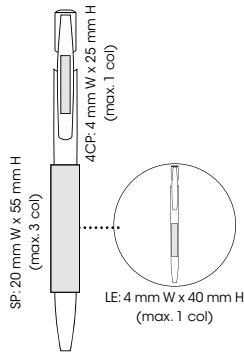

1D25 Ballpen / Bille / Bolígrafo / Kugelschreiber / Sfera

- Weighted barrel design
- Mix & Match metallic components

- Structure du corps densifiée
- Assortissez les éléments métallisés

- Cuerpo diseñado con peso interno
- Combina los componentes metálicos

- Gut gewichteter Schaff
- Mix & Match metallische Komponenten

- Corpo disegnato con peso all' interno
- Mix & Match dei componenti metallic

Imprint

SP: clip 1 colour / barrel up to 3 colours
LE: barrel 1 colour

Impression

SP: clip 1 couleur / corps jusqu'à 3 couleurs
LE: corps 1 couleur

Impresión

SP: clip 1 color / cuerpo hasta 3 colores
LE: cuerpo 1 color

Personalisierung

SP: Clip 1 Farbe / Schaff max. 3 Farben
LE: Schaff 1 Farbe

Stampa

SP: clip 1 colore / corpo max. 3 colori
LE: corpo 1 colore

Min Qty.: 250 units



BIC® Easy-Glide Ink™ or
BIC® Fraud Defense Ink™ option



= 3.7 Kg (approx.)



pg 162

Please refer to page 4 for icon definitions.

www.bicgraphic.com 21



Clip and Section Opaque



Frosted

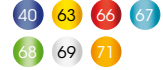

Barrel Opaque



Frosted

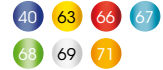

BIC® Clic Stic™:
(1,3 cm W x 14 cm H)

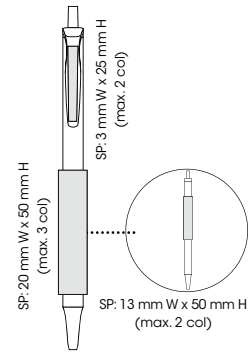

1000 Ballpen / Bille / Bolígrafo / Kugelschreiber / Sfera

- Break resistant pocket clip
- Mix & match the components

Imprint
SP: clip up to 2 colours / barrel up to 3 colours

- Clip incassable
- Assortissez les éléments

Impression
SP: clip jusqu'à 2 couleurs / corps jusqu'à 3 couleurs

- Clip irrompible sujetable en bolsillo
- Combina los componentes

Impresión
SP: clip hasta 2 colores / cuerpo hasta 3 colores

- Bruchsicherer Clip
- Mix & match aller Komponenten

Personalisierung
SP: Clip max. 2 Farben / Schaff max. 3 Farben

- Clip resistente a rotture
- Mix & Match dei componenti

Stampa
SP: clip max. 2 colori / corpo max. 3 colori



M



500



Soft Feel®

Clip and Section
Opaque



Frosted

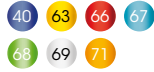

Barrel
Opaque



Frosted



BIC® Soft Feel®:
(1,3 cm W x 14 cm H)

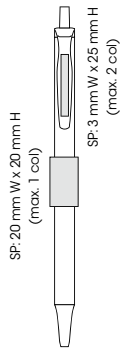

1005 Ballpen / Bille / Bolígrafo / Kugelschreiber / Sfera

• Soft feel
barrel

• Corps doux
au toucher

• Cuerpo de
tacto suave

• Angenehm
weicher Schaff

• Corpo morbido
al tatto

Imprint

SP: clip up to 2 colours /
barrel 1 colour

Impression

SP: clip jusqu'à 2 couleurs /
corps 1 couleur

Impresión

SP: clip hasta 2 colores /
cuerpo 1 color

Personalisierung

SP: Clip max. 2 Farben /
Schaff 1 Farbe

Stampa

SP: clip max. 2 colori /
corpo 1 colore

Min Qty.: 500 units



● ● BIC® Easy-Glide Ink™ or
BIC® Fraud Defense Ink™ option



= 2,6 Kg (approx.)



pg 162

Please refer to page 4 for icon definitions.

www.bicgraphic.com 23



Clic Stic™ Grip



Clip and Section / Ink:
Opaque



Barrel:
Opaque



BIC® Clic Stic™ Grip:
(0,85 cm W x 13,7 cm H)

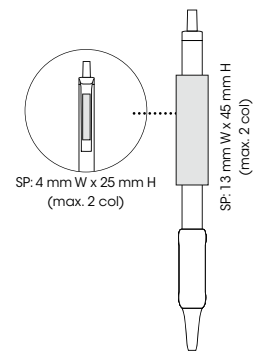

1845 Ballpen / Bille / Bolígrafo / Kugelschreiber / Sfera

- Break resistant pocket clip
- Soft, rubber grip

Imprint

SP: clip up to 2 colours / barrel up to 2 colours

- Clip incassable
- Grip caoutchouc

Impression

SP: clip jusqu'à 2 couleurs / corps jusqu'à 2 couleurs

- Clip resistente
- Suave grip de goma

Impresión

SP: clip hasta 2 colores / cuerpo hasta 2 colores

- Bruchsicherer Clip
- Angenehm weiche Griffzone

Personalisierung

SP: Clip max. 2 Farben / Schaff max. 2 Farben

- Clip resistenti a rotture
- Grip in gomma morbido al tatto

Stampa

SP: clip max. 2 colori / corpo max. 2 colori



Clic Stic™ Ice Grip

Clip and Grip:
Frosted

69



Barrel / Ink:
Frosted

51 67 40



BIC® Clic Stic™ Ice Grip:
(0,85 cm W x 13,7 cm H)

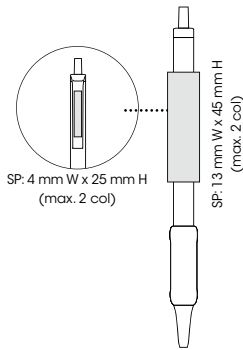

1846 Ballpen / Bille / Bolígrafo / Kugelschreiber / Sfera

- Break resistant pocket clip
- Soft, rubber grip

- Clip incassable
- Grip caoutchouc

- Clip resistente
- Suave grip de goma

- Bruchsischerer Clip
- Angenehm weiche Griffzone

- Clip resistenti a rotture
- Grip in gomma morbido al tatto

Imprint

SP: clip up to 2 colours / barrel up to 2 colours

Impression

SP: clip jusqu'à 2 couleurs / corps jusqu'à 2 couleurs

Impresión

SP: clip hasta 2 colores / cuerpo hasta 2 colores

Personalisierung

SP: Clip max. 2 Farben / Schaff max. 2 Farben

Stampa

SP: clip max. 2 colori / corpo max. 2 colori

Min Qty: 500 units



M



= 3,2 Kg (approx.)



pg 162

Please refer to page 4 for icon definitions.



Clip and Section Opaque



Frosted



Barrel Opaque



BIC® Clic Stic™ Digital :
(1,3 cm W x 14 cm H)

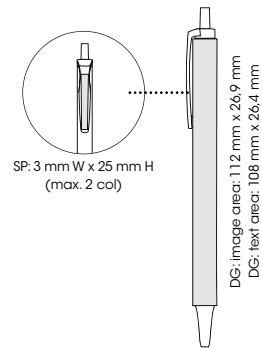

1882 Ballpen / Bille / Bolígrafo / Kugelschreiber / Sfera

- High impact at a very low price
- Low quantities for digital printing

- Fort impact à un tout petit prix
- Faibles quantités pour une impression numérique

- Alto impacto a bajo coste
- Impresión digital a partir de pequeñas cantidades

- Hohe Werbewirkung zu einem kleinen Preis
- Geringe Abnahmemengen für Digitaldruck

- Alto impatto al giusto prezzo
- Piccole quantità per stampa digitale

Imprint

DG: barrel
SP: clip up to 2 colours

Impression

DG: corps
SP: clip jusqu'à 2 couleurs

Impresión

DG: cuerpo
SP: clip hasta 2 colores

Personalisierung

DG: Schaft
SP: Clip max. 2 Farben

Stampa

DG: corpo
SP: clip max. 2 colori





Clic Stic™ Mini Digital

Clip and Section
Opaque



Frosted



Barrel
Opaque



BIC® Clic Stic™ Mini Digital :
(1,25 cm W x 11,4 cm H)



1892 Ballpen / Bille / Bolígrafo / Kugelschreiber / Sfera

- High quality result
- Low quantities for digital printing

- Résultat de haute qualité
- Faibles quantités pour une impression numérique

- Resultados de alta calidad
- Impresión digital a partir de pequeñas cantidades

- Höchste Qualität
- Geringe Abnahmemengen für Digitaldruck

- Risultati di alta qualità
- Piccole quantità per stampa digitale

Imprint
DG: barrel

Impression
DG: corps

Impresión
DG: cuerpo

Personalisierung
DG: Schaft

Stampa
DG: corpo

Min Qty.: 500 units



BIC® Easy-Glide Ink™ or
BIC® Fraud Defense Ink™ option



= 2,6 / 2,7 Kg (approx.)



pg 162

Please refer to page 4 for icon definitions.



Tri Stic™



Barrel and Trims / Ink
Opaque



BIC® Tri Stic™:
(1,27 cm W x 13,8 cm H)

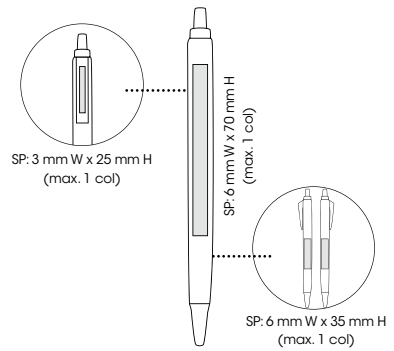

1070 Ballpen / Bille / Bolígrafo / Kugelschreiber / Sfera

- 3-sided barrel, 3 different imprint areas available for maximum communication

Imprint
SP: Clip 1 colour / barrel 1 colour on 3 sides

- Corps triangulaire personnalisable sur les 3 faces pour une communication maximale

Impression
SP: Clip 1 couleur / 1 couleur par surface sur le corps

- Cuerpo de 3 lados 3 áreas de impresión diferentes para una máxima comunicación

Impresión
SP: Clip 1 color / 1 color en cada cara del cuerpo

- 3 Druckflächen auf 3-kantigem Schaff für eine maximale Werbewirkung

Personalisierung
SP: Clip 1 Farbe / Schaff: 1 Farbe auf 3 Seiten

- Corpo trifacciale 3 differenti aree di stampa utilizzabili per una massima comunicazione

Stampa
SP: Clip 1 colore / 1 colore per ciascun lato del corpo





Tri Stic™ Clear

Barrel / Ink
Clear



Trims
Clear



BIC® Tri Stic™ Clear:
(1,27 cm W x 13,8 cm H)

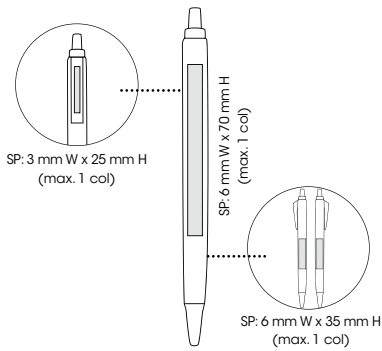

1071 Ballpen / Bille / Bolígrafo / Kugelschreiber / Sfera

- 3-sided barrel, 3 different imprint areas available for maximum communication

- Corps triangulaire personnalisable sur les 3 faces pour une communication maximale

- Cuerpo de 3 lados 3 áreas de impresión diferentes para una máxima comunicación

- 3 Druckflächen auf 3-kantigem Schaft für eine maximale Werbewirkung

- Corpo trifacciale 3 differenti aree di stampa utilizzabili per una massima comunicazione

Imprint

SP: Clip 1 colour / barrel 1 colour on 3 sides

Impression

SP: Clip 1 couleur / 1 couleur par surface sur le corps

Impresión

SP: Clip 1 color / 1 color en cada cara del cuerpo

Personalisierung

SP: Clip 1 Farbe / Schaft: 1 Farbe auf 3 Seiten

Stampa

SP: Clip 1 colore / 1 colore per ciascun lato del corpo

Min Qty.: 250 units



500 = 3,6 Kg (approx.)



Only 1 colour on 1 side



pg 162

Please refer to page 4 for icon definitions.



Barrel / Trims / Ink
Opaque

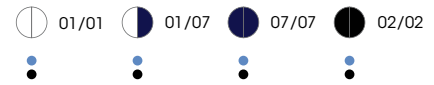

BIC® Vision™ Clic:
(1,4 cm W x 14,5 cm H)

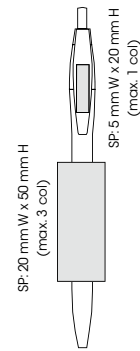

1050 Ballpen / Bille / Bolígrafo / Kugelschreiber / Sfera

- Eye-catching contoured barrel design

Imprint
SP: clip 1 colour / barrel up to 3 colours

- Design attrayant de la gaine profilée

Impression
SP: clip 1 couleur / corps jusqu'à 3 couleurs

- Llamativo diseño de cuerpo moldeado

Impresión
SP: clip 1 color / cuerpo hasta 3 colores

- Auffallend geformtes Schaff-Design

Personalisierung
SP: Clip 1 Farbe / Schaff max. 3 Farben

- Accattivante design sagomato del corpo

Stampa
SP: clip1 colore / corpo max. 3 colori



Vision™ Clear

Barrel / Trims / Ink
Clear

● 86/86 ● 91/91



BIC® Vision™ Clear:
(1,4 cm W x 14,5 cm H)

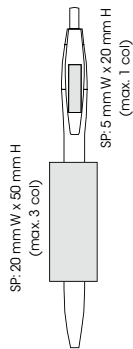

1052 Ballpen / Bille / Bolígrafo / Kugelschreiber / Sfera

• Large personalisation area

• Grande zone d'impression

• Amplia área de impresión

• Große Druckfläche

• Ampia area di personalizzazione

Imprint

SP: clip 1 colour / barrel up to 3 colours

Impression

SP: clip 1 couleur / corps jusqu'à 3 couleurs

Impresión

SP: clip 1 color / cuerpo hasta 3 colores

Personalisierung

SP: Clip 1 Farbe / Schaff max. 3 Farben

Stampa

SP: clip 1 colore / corpo max. 3 colori

Min Qty.: 250



250 = 2 Kg (approx.)



pg 162

Please refer to page 4 for icon definitions.



Upper part and Lower barrel

Opaque

01 02 03 05 07 12

Clear

51 86 87 88 89

Ring

Opaque

01 02 03 05 07 12

Clear

26 46

51 86 87 88 89

BIC® Pivo®:
(1 cm W x 14,2 cm H)

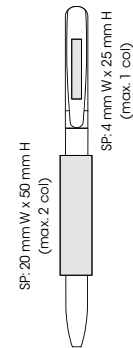

1035 Ballpen / Bille / Bolígrafo / Kugelschreiber / Sfera

• Sleek slim profile with twist retractable action

• Profil fin avec action rétractable rotative

• Perfil esbelto y elegante con mecanismo de giro retráctil

• Glattes, schmales Profil mit einem Drehmechanismus

• Profilo sottile liscio con azione a scatto

Imprint

SP: clip 1 colour / barrel up to 2 colours

Impression

SP: clip 1 couleur / corps jusqu'à 2 couleurs

Impresión

SP: clip 1 color / cuerpo hasta 2 colores

Personalisierung

SP: Clip 1 Farbe / Schaff max. 2 Farben

Stampa

SP: clip 1 colore / corpo max. 2 colori





Wide Body™

Barrel, Clip and Section
Opaque



Frosted

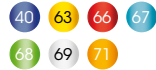

BIC® Wide Body™:
(1,6 cm W x 14,2 cm H)

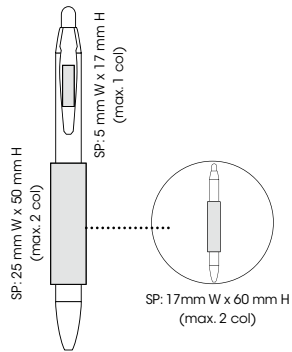

1080 Ballpen / Bille / Bolígrafo / Kugelschreiber / Sfera

• Wide-profile design with large imprint area

• Profil large avec large zone d'impression

• Diseñado para maximizar el área de impresión

• Klassisches Design mit großer Druckfläche

• Design con grande area di personalizzazione

Imprint

SP: clip 1 colour / barrel up to 2 colours

Impression

SP: clip 1 couleur / corps jusqu'à 2 couleurs

Impresión

SP: clip 1 color / cuerpo hasta 2 colores

Personalisierung

SP: Clip 1 Farbe / Schaff max. 2 Farben

Stampa

SP: clip 1 colore / corpo max. 2 colori

Min Qty.: 250 units



M

●

BIC® Easy-Glide Ink™ or BIC® Fraud Defense Ink™ option



250 = 2,6 Kg (approx.)



BIC ecolutions
Recycled Content
Option pg 139



pg 162

Please refer to page 4 for icon definitions.



Wide Body™ Grip



Clip and Grip
Opaque

03 04 07 12 20

Barrel
Opaque

01

BIC® Wide Body™Grip:
(1,2 cm W x 14,2 cm H)

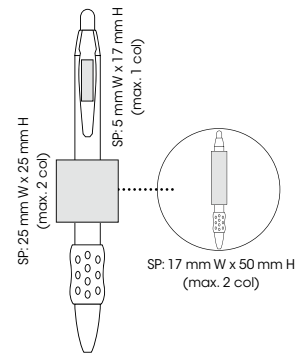

1082 Ballpen / Bille / Bolígrafo / Kugelschreiber / Sfera

• Soft rubber grip with large imprint area

Imprint
SP: clip 1 colour / barrel up to 2 colours

• Zone de préhension en caoutchouc souple avec large zone d'impression

Impression
SP: clip 1 couleur / corps jusqu'à 2 couleurs

• Grip suave de caucho con amplia área de impresión

Impresión
SP: clip 1 color / cuerpo hasta 2 colores

• Weiche Griffzone und großzügige Druckfläche

Personalisierung
SP: Clip 1 Farbe / Schaff max. 2 Farben

• Impugnatura in gomma morbida con ampia area di stampa

Stampa
SP: clip 1 colore / corpo max. 2 colori





Wide Body™ Clear Grip

Barrel, Clip and Grip
Clear

72 87 89

BIC® Wide Body™ Clear Grip:
(1,2 cm W x 14,2 cm H)

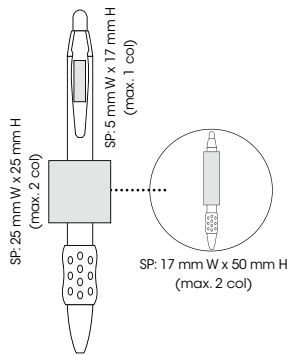

1088 Ballpen / Bille / Bolígrafo / Kugelschreiber / Sfera

- Soft rubber grip with large imprint area

- Zone de préhension en caoutchouc souple avec large zone d'impression

- Grip suave de caucho con amplia área de impresión

- Weiche Griffzone und großzügige Druckfläche

- Impugnatura in gomma morbida con ampia area di stampa

Imprint

SP: clip 1 colour / barrel up to 2 colours

Impression

SP: clip 1 couleur / corps jusqu'à 2 couleurs

Impresión

SP: clip 1 color / cuerpo hasta 2 colores

Personalisierung

SP: Clip 1 Farbe / Schaff max. 2 Farben

Stampa

SP: clip 1 colore / corpo max. 2 colori

Min Qty.: 250 units

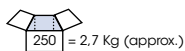

pg 162

Please refer to page 4 for icon definitions.



Wide Body™ Ice Grip



Grip, Clip and Section
Frosted

69

Barrel
Clear

51 86 88 89 92 93

BIC® Wide Body™ Ice Grip:
(1,2 cm W x 14,2 cm H)

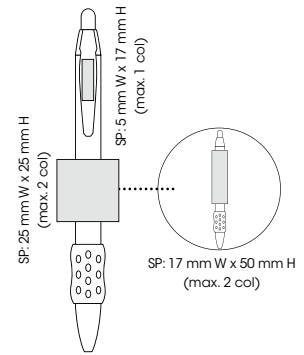

1084 Ballpen / Bille / Bolígrafo / Kugelschreiber / Sfera

• Soft rubber grip with large imprint area

Imprint
SP: clip 1 colour / barrel up to 2 colours

• Zone de préhension en caoutchouc souple avec large zone d'impression

Impression
SP: clip 1 couleur / corps jusqu'à 2 couleurs

• Grip suave de caucho con amplia área de impresión

Impresión
SP: clip 1 color / cuerpo hasta 2 colores

• Weiche Griffzone und großzügige Druckfläche

Personalisierung
SP: Clip 1 Farbe / Schaft max. 2 Farben

• Impugnatura in gomma morbida con ampia area di stampa

Stampa
SP: clip 1 colore / corpo max. 2 colori





Wide Body™ Digital

Clip and Section
Opaque



Frosted

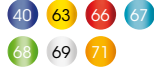

Barrel
Opaque



BIC® Wide Body™ Digital:
(1,6 cm W x 14,2 cm H)

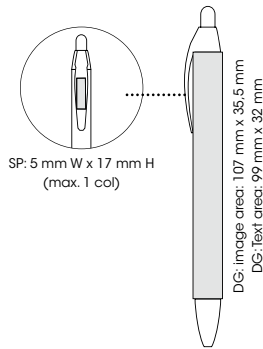

1878 Ballpen / Bille / Bolígrafo / Kugelschreiber / Sfera

• High quality results at a low cost

• Résultats de haute qualité à petit prix

• Resultados de alta calidad a bajo coste

• Optimale Werbewirkung zum kleinen Preis

• Risultati ad alta qualità a prezzi bassi

Imprint
DG: barrel
SP: clip 1 colour

Impression
DG: corps
SP: clip 1 couleur

Impresión
DG: cuerpo
SP: clip 1 color

Personalisierung
DG: Schaff
SP: Clip 1 Farbe

Stampa
Dg: corpo
SP: clip 1 colore

Min Qty.: 500 units



M ●● BIC® Easy-Glide Ink™ or BIC® Fraud Defense Ink™ option



= 2,6 Kg (approx.)

BIC ecolutions
Recycled Content
Option pg 140



pg 162

Please refer to page 4 for icon definitions.



Mini Wide Body™ Digital



Clip and Section Opaque

- 01
- 02
- 03
- 07
- 18

Frosted

- 40
- 63
- 66
- 67
- 68
- 69
- 71

Barrel Opaque

- 01



BIC® Mini Wide Body™ Digital:
(1,6 cm W x 11,6 cm H)

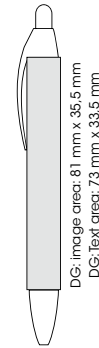

1893 Ballpen / Bille / Bolígrafo / Kugelschreiber / Sfera

- High quality results at a low cost

- Résultats de haute qualité à petit prix

- Resultados de alta calidad a bajo coste

- Optimale Werbewirkung zum kleinen Preis

- Risultati ad alta qualità a prezzi bassi

Imprint
DG: barrel

Impression
DG: corps

Impresión
DG: cuerpo

Personalisierung
DG: Schaff

Stampa
DG: corpo



Plug, Grip, Section and Clip
Opaque



Frosted



Barrel
Opaque



Frosted



BIC® Media Max:
(1,35 cm W x 14,3 cm H)

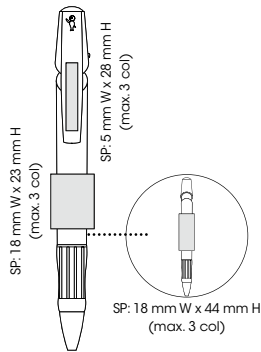

1030 Ballpen / Bille / Bolígrafo / Kugelschreiber / Sfera
1033 Pencil / Porte-mines / Portaminas / Druckbleistift / Portamine

- Soft, sleek gripping section
- Extra wide barrel for maximum imprint area

- Partie grip lisse et douce
- Corps extra large pour une surface de marquage maximale

- Grip suave
- Cuerpo extra ancho para una zona máxima de impresión

- Angenehm weiche Griffzone
- Extra breiter Schaft für eine maximale Werbefläche

- Grip morbida
- Design con grande area di personalizzazione

Imprint

SP: clip up to 3 colours / barrel up to 3 colours

Impression

SP: clip jusqu'à 3 couleurs / corps jusqu'à 3 couleurs

Impresión

SP: clip hasta 3 colores / cuerpo hasta 3 colores

Personalisierung

SP: Clip max. 3 Farben / Schaft max. 3 Farben

Stampa

SP: clip max. 3 colori / corpo max. 3 colori

Min Qty: 500 units M MP Ø 0,7 mm = 6 Kg (approx.)

BIC® Easy-Glide Ink™ or
BIC® Fraud Defense Ink™ option



*Except pencil



pg 162

Please refer to page 4 for icon definitions.



Plug, Grip, Section and Clip

Opaque



Frosted



Barrel

Opaque



BIC® Media Max Digital:
(1,35 cm W x 14,3 cm H)

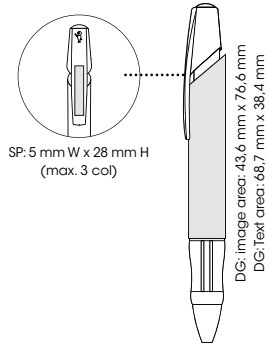

1874 Ballpen / Bille / Bolígrafo / Kugelschreiber / Sfera

1877 Pencil / Porte-mines / Portaminas / Druckbleistift / Portamine

• Soft, sleek gripping section

• Partie grip en caoutchouc

• Grip esbelto y suave

• Weiche, glatte Griffzone

• Grip morbida e liscia

Imprint

SP: clip up to 3 colours
DG: barrel

Impression

SP: clip jusqu'à 3 couleurs
DG: corps

Impresión

SP: clip hasta 3 colores
DG: cuerpo

Personalisierung

SP: Clip max. 3 Farben
DG: Schaft

Stampa

SP: clip max. 3 colori
DG: corpo



Media Max Premium

Plug and Section

35



Grip

02 69

Barrel and Clip

4A 5A 6A 7A
8A 9A

BIC® Media Max Premium:
(1,35 cm W x 14,3 cm H)

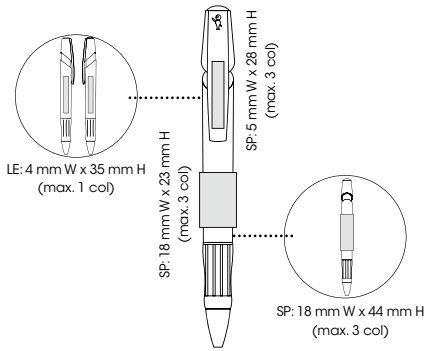

1D30 Ballpen / Bille / Bolígrafo / Kugelschreiber / Sfera
1D33 Pencil with eraser / Porte-mines avec gomme / Portamines con goma / Druckbleistift mit Radiergummi / Portamine con gomma

- High quality metallised product
- Premium metallic finish

- Produit métallisé de haute qualité
- Finition métallisée haut de gamme

- Producto metalizado de alta calidad
- Acabado metálico premium

- Hochwertiger Kugelschreiber
- Metalloptik

- Alta qualità del prodotto metallizzato
- Finiture in metallo

Imprint

SP: clip up to 3 colours / barrel up to 3 colours
LE: barrel 1 colour

Impression

SP: clip jusqu'à 3 couleurs / corps jusqu'à 3 couleurs
LE: corps 1 couleur

Impresión

SP: clip hasta 3 colores / cuerpo hasta 3 colores
LE: cuerpo 1 color

Personalisierung

SP: Clip max. 3 Farben / Schaff max. 3 Farben
LE: Schaff 1 Farbe

Stampa

SP: clip max. 3 colori / corpo max. 3 colori
LE: corpo 1 colore

Min Qty: 250 units M MP Ø 0,7 mm = 5,3 Kg (approx.)

BIC® Easy-Glide Ink™ or
BIC® Fraud Defense Ink™ option



* Except pencil



pg 162

Please refer to page 4 for icon definitions.



Plug and Section

35

Grip

02 69

Clip

4A 5A 6A 7A
8A 9A

Barrel

Opaque

01



BIC® Media Max Premium Digital:
(1,35 cm W x 14,3 cm H)

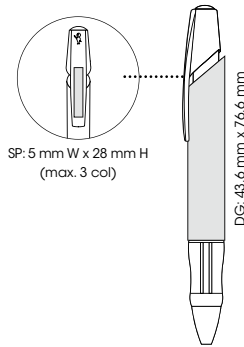

1883 Ballpen / Bille / Bolígrafo / Kugelschreiber / Sfera
1884 Pencil with eraser / Porte-mines avec gomme / Portaminas con goma / Druckbleistift mit Radiergummi / Portamine con gomma

• Enables to print full color images

• Permet l'impression d'images en couleur

• Permite imprimir imágenes full color

• Vollfarbige Bilder werden Realität

• Permette stampa digitale

Imprint

SP: clip up to 3 colours
DG: barrel

Impression

SP: clip jusqu'à 3 couleurs
DG: corps

Impresión

SP: clip hasta 3 colores
DG: cuerpo

Personalisierung

SP: Clip max. 3 Farben
DG: Schaff

Stampa

SP: clip max. 3 colori
DG: corpo



Atlantis®

Barrel / Trims / Ink

Opaque



Clear Barrel / Opaque Trims / Ink

Opaque



BIC® Atlantis® :
(0,9 cm W x 14,4 cm H)

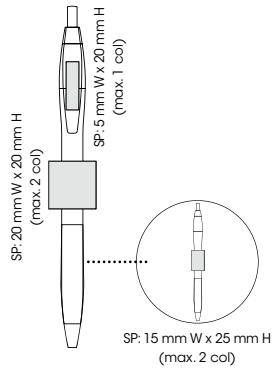

1060 Ballpen / Bille / Bolígrafo / Kugelschreiber / Sfera

- Large gripping section
- Modern design

- Grande section de préhension
- Design moderne

- Amplio grip
- Diseño moderno

- Große Griffzone
- Modernes Design

- Amplia grip
- Design moderno

Imprint

SP: clip 1 colour / barrel up to 2 colours

Impression

SP: clip 1 couleur / corps jusqu'à 2 couleurs

Impresión

SP: clip 1 color / cuerpo hasta 2 colores

Personalisierung

SP: Clip 1 Farbe / Schaff max. 2 Farben

Stampa

SP: clip 1 colore / corpoi max. 2 colori

Min Qty.: 250 units



250 = 2,3 Kg (approx.)



pg 162

Please refer to page 4 for icon definitions.



Barrel / Ink
Opaque

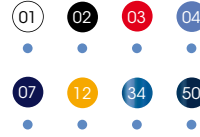

Clip / Trims

35

BIC® Clic:
(1,1 cm W x 14,5 cm H)

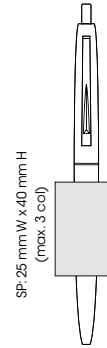

1093 Ballpen / Bille / Bolígrafo / Kugelschreiber / Sfera

• Made of 25% plastic from a renewable resource

• Fabriqué à base de 25% de plastique provenant de ressources renouvelables

• Hecho de un 25% de plástico procedente de recursos renovables

• Hergestellt mit 25% Kunststoff aus erneuerbaren Rohstoffen

• Prodotto con il 25% di plastica proveniente da risorse rinnovabili

Imprint

SP: barrel up to 3 colours

Impression

SP: corps jusqu'à 3 couleurs

Impresión

SP: cuerpo hasta 3 colores

Personalisierung

SP: Schaff max. 3 Farben

Stampa

SP: corpo max. 3 colori



Clic Gold

Barrel / Ink
Opaque



Clear*



Clip / Trims



BIC® Clic Gold:
(1,1 cm W x 14,5 cm H)

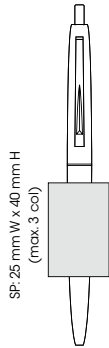

1091 Ballpen / Bille / Bolígrafo / Kugelschreiber / Sfera
1090* Ballpen / Bille / Bolígrafo / Kugelschreiber / Sfera

• Made of 25% plastic from a renewable resource

• Fabriqué à base de 25% de plastique provenant de ressources renouvelables

• Hecho de un 25% de plástico procedente de recursos renovables

• Hergestellt mit 25% Kunststoff aus erneuerbaren Rohstoffen

• Prodotto con il 25% di plastica proveniente da risorse rinnovabili

Imprint

SP: barrel up to 3 colours

Impression

SP: corps jusqu'à 3 couleurs

Impresión

SP: cuerpo hasta 3 colores

Personalisierung

SP: Schaff max. 3 Farben

Stampa

SP: corpo max. 3 colori

Min Qty: 250 units



M



BIC® Fraud Defense Ink™ option



= 2.3 Kg (approx.)



pg 162

Please refer to page 4 for icon definitions.

www.bicgraphic.com 45



Barrel
Opaque Clear

01 02 07 86

BIC® Citation™:
(1,25 cm W x 14 cm H)

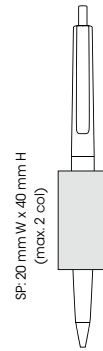

1620 Ballpen / Bille / Bolígrafo / Kugelschreiber / Sfera

• Polished nickel plated trim

• Corps en nickel poli

• Atributos plateados de nickel pulido

• Beschläge vernickelt und poliert

• Particolari placati in nickel

Imprint
SP: barrel up to 2 colours

Impression
SP: corps jusqu'à 2 couleurs

Impresión
SP: cuerpo hasta 2 colores

Personalisierung
SP: Schaff max. 2 Farben

Stampa
SP: corpo max. 2 colori



Intensity® Gel Clic

Barrel
Clear



Opaque



BIC® Intensity® Gel Clic:
(1,45 cm W x 14,5 cm H)

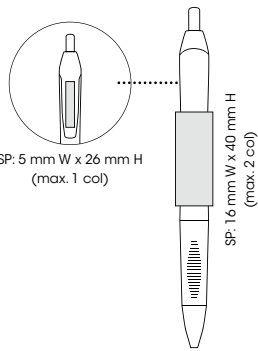

1196 Gel / Gel / Gel / Gelschreiber / Gel

- Ultra-smooth gel roller
- Automatic clip retracting mechanism
- Chrome plated section
- Acid-free ink

- Roller à encre gel ultra-doux
- Mécanisme de rétractation automatique de clip
- Section en chrome poli
- Encre sans acide

- Roller de gel ultra suave.
- Mecanismo automático de clip retráctil
- Sección cromada
- Tinta libre de ácido

- Gel-Tinte für angenehmen Schreibkomfort
- Gelschreiber mit Druckmechanismus
- Verchromte Spitze
- Säurefreie Tinte

- Ultra-fluido gel roller
- Clip con meccanismo a scatto
- Sezione cromata
- Inchiostro privo di componenti acidi

Imprint

SP: clip up to 1 colour / barrel up to 2 colours

Impression

SP: clip 1 couleur / corps jusqu'à 2 couleurs

Impresión

SP: clip 1 color / cuerpo hasta 2 colores

Personalisierung

SP: Clip 1 Farbe / Schaft max. 2 Farben

Stampa

SP: clip 1 colore / corpoi max. 2 colori

Min Qty.: 250 units



G ●



250

= 3,7 Kg (approx.)



pg 162

Please refer to page 4 for icon definitions.

www.bicgraphic.com 47



4 Colours & 4 Colours Pen with Lanyard NEW!



BIC® 4 Colours

BIC® 4 Colours Pen with Lanyard

Barrel
Opaque

01 07

Clip
Opaque

01

BIC® 4 Colours & Pen with Lanyard:
(1,6 cm W x 11,7 cm H)

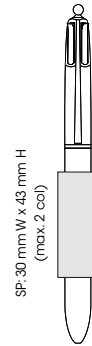

BIC® 4 Colours

1100 Ballpen / Bille / Bolígrafo / Kugelschreiber / Sfera

BIC® 4 Colours Pen with Lanyard

1101* Ballpen / Bille / Bolígrafo / Kugelschreiber / Sfera

- Four different ink colors in one!
- Multi-functional design

- Quatre couleurs d'encre différentes en un stylo!
- Design multifonction

- 4 colores diferentes de tintas en un producto!
- Diseño multi funcional

- Vier Schreibfarben in einem Schreibgerät!
- Multifunktionales Design

- Quattro differenti colori di inchiostro in uno!
- Design multifunzionale

Imprint

SP: barrel up to 2 colours

Impression

SP: corps jusqu'à 2 couleurs

Impresión

SP: cuerpo hasta 2 colores

Personalisierung

SP: Schaff max. 2 Farben

Stampa

SP: corpo max. 2 colori





Grip Roller

Barrel and Cap / Clip / Ink
Opaque

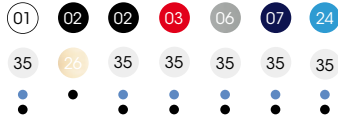

BIC® Grip Roller:
(1,5 cm W x 13,9 cm H)

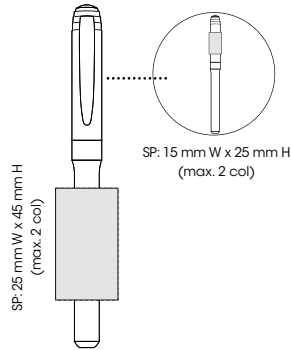

1187 Chrome
1195 Gold

• Fast drying ink for clean and precise writing

• Encre à séchage rapide pour une écriture propre et précise

• Tinta de secado rápido para una escritura limpia y precisa

• Schnell trocknende Tinte für sauberes und präzises Schreiben

• Inchiostro ad asciugatura rapida per una scrittura pulita ed accurata

Imprint
SP: cap and barrel up to 2 colours

Impression
SP: capuchon et corps jusqu'à 2 couleurs

Impresión
SP: capuchón y cuerpo hasta 2 colores

Personalisierung
SP: Kappe und Schaft max. 2 Farben

Stampa
SP: cappuccio e corpo max. 2 colori

Min Qty.: 250 units



R

●

●



= 3 Kg (approx.)



pg 162

Please refer to page 4 for icon definitions.



Barrel and Cap / Ink
Opaque



BIC® Brite Liner® Grip:
(1,4 cm W x 13,7 cm H)

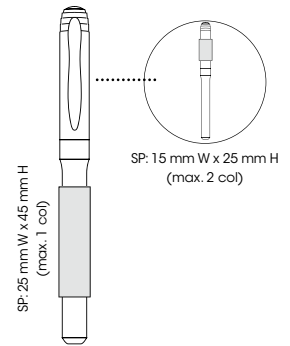

1192 Highlighter / Surligneur / Resaltador / Leuchtmarker / Evidenziatore

• Highlight your message

Imprint
SP: cap up to 2 colours / barrel 1 colour

• Souligne votre message

Impression
SP: Capuchon jusqu'à 2 couleurs / corps 1 couleur

• Resalta tu mensaje

Impresión
SP: Capuchón hasta 2 colores / cuerpo 1 color

• Heben Sie Ihre Werbebotschaft hervor

Personalisierung
SP: Kappe max. 2 Farben / Schaft 1 Farbe

• Evidenzia il tuo messaggio

Stampa
SP: Cappuccio max. 2 colori / corpo 1 colore



Brite Liner® Grip XL REFRESH!

Barrel and Cap / Ink
Opaque



BIC® Brite Liner® Grip XL:
(2 cm W x 13,8 cm H)

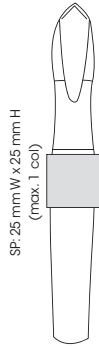

1193 Highlighter / Surligneur / Resaltador /
Leuchtmarker / Evidenziatore

- Chisel tip for broad highlighting and fine underlining
- Textured rubber grip for comfort and control

- Pointe ciselée pour surligner et soulignement fin.
- Grip en caoutchouc texturé pour plus de confort et de contrôle d'écriture

- Punta cincelada para remarcar en grueso y subrayar en fino
- Grip de goma con relieve para mayor comodidad y control

- Abgeschrägte Spitze für breites Markieren und feines Unterstreichen
- Komfortable Griffzone mit Struktur

- Punta a scalpello per un'evidenziazione larga e una sottolineatura perfetta
- Grip in gomma tramata per una stampa confortevole e controllata

Imprint

SP: barrel 1 colour

Impression

SP : corps 1 couleur

Impresión

SP: cuerpo 1 color

Personalisierung

SP: Schaff 1 Farbe

Stampa

SP: Corpo 1 colore

Min Qty.: 250 units



= 2.8 Kg (approx.)



pg 162

Please refer to page 4 for icon definitions.



Barrel
Opaque

02

Cap / Ink
Opaque

02

04

BIC® Permanent Marker:
(2 cm W x 13,8 cm H)

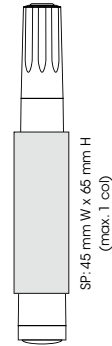

1210 Marquer / Marqueur / Marcador / Permanent Marker / Marcatore

- Writes on virtually any surface
- Large imprint area

Imprint
SP: barrel 1 colour

- Écrit sur quasiment toutes les surfaces
- Large zone d'impression

Impression
SP: corps 1 couleur

- Escribe sobre cualquier superficie
- Amplia área de impresión

Impresión
SP: cuerpo 1 color

- Schreibt auf fast allen Oberflächen
- Große Druckfläche

Personalisierung
SP: Schäft 1 Farbe

- Scrive su qualsiasi superficie
- Ampia area di stampa

Stampa
SP: corpo 1 colore



Mark-it Permanent Marker NEW!

Barrel
Opaque

01

Cap / Ink
Opaque

02

04

BIC® Mark-it Permanent Marker:
(1,4 cm W x 16,5 cm H)

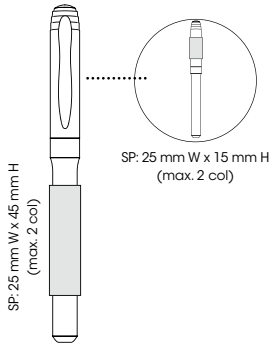

1214 Marquer / Marqueur / Marcador / Permanent Marker / Marcatore

- Fade-resistant, vivid ink
- Acid-free ink

- Encre vive, résistante à la décoloration
- Encre sans acide

- Tinta intensa, resistente a la pérdida de color
- Tinta libre de ácido

- Leuchtende Tinte, nicht bleichend
- Säurefreie Tinte

- Inchiostro vivido, resistente allo sbiadimento
- Inchiostro privo di componenti acidi

Imprint

SP: cap up to 2 colours / barrel 2 colours

Impression

SP : capuchon jusqu'à 2 couleurs / corps 2 couleurs

Impresión

SP: capuchón hasta 2 colores / cuerpo 2 colores

Personalisierung

SP: Kappe bis zu 2 Farben / Schaft 2 Farben

Stampa

SP: cappuccio fino a 2 colori / corpo a 2 colori

Min Qty.: 250 units



250 = 2.8 Kg (approx.)



pg 162

Please refer to page 4 for icon definitions.



Barrel
Opaque

01

Cap / Ink
Opaque

02

BIC® Great Erase White Board Marker:
(1,6 cm W x 13,9 cm H)

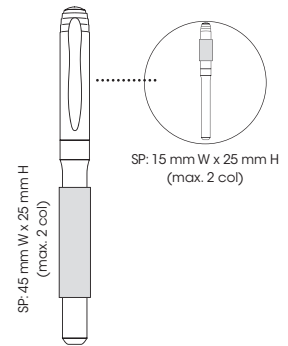

1213 Marquer / Marqueur / Marcador / Permanent Marker / Marcatore

- Perfect for use on dry erase boards, glass and most non-porous surfaces
- Easily erases with a dry cloth, tissue or felt eraser!

- Convient parfaitement pour une utilisation sur tableau blanc, le verre et la plupart des surfaces non poreuses
- S'efface facilement avec un chiffon sec, un papier-mouchoir ou un effaceur-feutre !

- Perfecto para usarlo en pizarras blancas, cristal y la mayoría de superficies no porosas
- ¡Borra fácilmente con un pañuelo o un borrador de fieltro!

- Besonders für den Gebrauch auf trockenen, abwischbaren Tafeln, Glas und den meisten nicht porösen Oberflächen geeignet
- Leicht mit einem trocknen Lappen, Papiertuch oder Filzschwamm abzuwischen

- Perfetto da usare su lavagne cancellabili a secco, vetro e la maggior parte delle superfici non-porose
- Si cancella facilmente con un panno asciutto, un fazzoletto o un cancellino in feltro!

Imprint

SP: cap up to 2 colours / barrel 2 colours

Impression

SP : capuchon jusqu'à 2 couleurs / corps 2 couleurs

Impresión

SP: capuchón hasta 2 colores / cuerpo 2 colores

Personalisierung

SP: Kappe bis zu 2 Farben/ Schaft 2 Farben

Stampa

SP: cappuccio fino a 2 colori / corpo a 2 colori

Barrel and Trims
Opaque



BIC® Matic:
(10 mm W x 50 mm H)

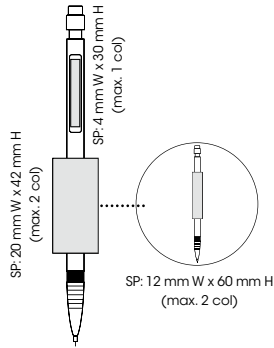

1120 Pencil / Mechanical Pencil / Porte-mines / Porta minas / Druckbleistift / Portamine



- Estimated writing length of 10.000 metres that provides write-out equivalent to 2^{1/2} woodcase pencil!
- Three 0.7mm #2 graphite lead

- Longueur d'écriture estimée de 10.000 mètres, l'équivalent à 2 crayons à papier et demi!
- Trois mines de graphite n°2 de 7mm

- ¡Longitud estimada de escritura de 10.000 metros que equivale a la escritura de 2,5 lápices de madera!
- Tres recambios de grafito de 0,7 mm

- Geschätzte Schreiblänge von 10.000 Meter, dies entspricht 2 1/2 Holzbleistiften!
- Drei 0,7 mm #2 Graphit-Minen

- Circa 10.000 metri di scrittura ininterrotta. Scrive circa 2 volte e mezzo quanto una normale matita in legno!
- Tre mine graffite da 0.7mm

Imprint

SP: clip 1 colour / barrel up to 2 colours

Impression

SP: clip 1 couleur / corps jusqu'à 2 couleurs

Impresión

SP: clip 1 color / cuerpo hasta 2 colores

Personalisierung

SP: Clip 1 Farbe / Schaff max. 2 Farben

Stampa

SP: clip 1 colore / corpo max. 2 colori

Min Qty: 500 units MP Ø 0,7 mm = 3,1 Kg (approx.)



pg 162

Please refer to page 4 for icon definitions.



Barrel and Trims Clear / Opaque

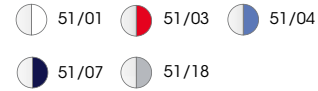

BIC® Matic Quartz:
(1,1 cm W x 15 cm H)

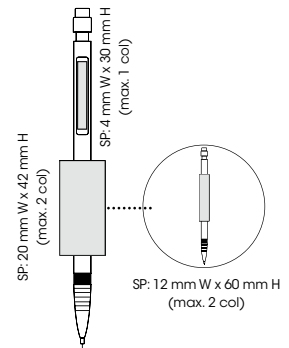

1121 Pencil / Mechanical Pencil / Porte-mines / Porta minas / Druckbleistift / Portamine

- Estimated writing length of 10.000 metres that provides write-out equivalent to 2^{1/2} woodcase pencil!
- Three 0.7mm #2 graphite lead

- Longueur d'écriture estimée de 10.000 mètres, l'équivalent à 2 crayons à papier et demi!
- Trois mines de graphite n°2 de 7mm

- ¡Longitud estimada de escritura de 10.000 metros que equivale a la escritura de 2,5 lápices de madera!
- Tres recambios de grafito de 0,7 mm

- Geschätzte Schreiblänge von 10.000 Meter, dies entspricht 2 1/2 Holzbleistiften!
- Drei 0,7 mm #2 Graphit-Minen

- Circa 10.000 metri di scrittura ininterrotta. Scrive circa 2 volte e mezzo quanto una normale matita in legno!
- Tre mine graffite da 0.7mm

Imprint

SP: clip 1 colour / barrel up to 2 colours

Impression

SP: clip 1 couleur / corps jusqu'à 2 couleurs

Impresión

SP: clip 1 color / cuerpo hasta 2 colores

Personalisierung

SP: Clip 1 Farbe / Schaff max. 2 Farben

Stampa

SP: clip 1 colore / corpo max. 2 colori



Matic Grip

Barrel and Trims Opaque

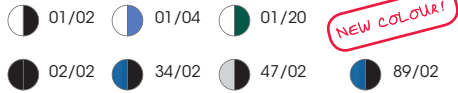

BIC® Matic Grip:
(10 cm W x 50 cm H)

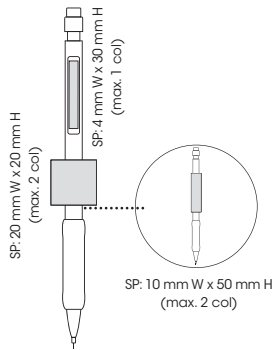

1122 Pencil / Mechanical Pencil / Porte-mines / Porta minas / Druckbleistift / Portamine



- Estimated writing length of 10.000 metres that provides write-out equivalent to 2^{1/2} woodcase pencil!
- Three 0.7mm #2 graphite lead

- Longueur d'écriture estimée de 10.000 mètres, l'équivalent à 2 crayons à papier et demi!
- Trois mines de graphite n°2 de 7mm

- ¡Longitud estimada de escritura de 10.000 metros que equivale a la escritura de 2,5 lápices de madera!
- Tres recambios de grafito de 0,7 mm

- Geschätzte Schreiblänge von 10.000 Meter, dies entspricht 2 1/2 Holzbleistiften!
- Drei 0,7 mm #2 Graphit-Minen

- Circa 10.000 metri di scrittura ininterrotta. Scrive circa 2 volte e mezzo quanto una normale matita in legno!
- Tre mine graffite da 0.7mm

Imprint

SP: clip 1 colour / barrel up to 2 colours

Impression

SP: clip 1 couleur / corps jusqu'à 2 couleurs

Impresión

SP: clip 1 color / cuerpo hasta 2 colores

Personalisierung

SP: Clip 1 Farbe / Schaft max. 2 Farben

Stampa

SP: clip 1 colore / corpo max. 2 colori

Min Qty: 500 units



MP Ø 0,7 mm



= 3,5 Kg (approx.)



pg 162

Please refer to page 4 for icon definitions.



Barrel
Opaque

01

BIC®Clic Matic:
(1,4 cm W x 14,8 cm H)

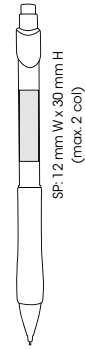

1126 Pencil / Mechanical Pencil / Porte-mines / Porta minas / Druckbleistift / Portamine

- Side lead advance mechanism
- Textured rubber grip for comfort and control

Imprint

SP: barrel up to 2 colours

- Mécanisme latéral d'avance de mine
- Grip en caoutchouc texturé pour plus de confort et de contrôle d'écriture

Impression

SP : corps jusqu'à 2 couleurs

- Mecanismo lateral de avance de la mina
- Grip de goma con relieve para comodidad y control

Impresión

SP: cuerpo hasta 2 colores

- Seitlicher Druckmechanismus für Minentransport
- Weiche Griffzone mit Struktur für Komfort und Kontrolle

Personalisierung

SP: Schaff bis zu 2 Farben

- Meccanismo di avanzamento laterale della mina
- Grip in gomma tramata per il massimo comfort e controllo

Stampa

SP: corpo fino a 2 colori



What Do You Get for a BIC®?

Quels sont les avantages d'un BIC®? / ¿Qué obtiene de un BIC®? / Was steckt in einem BIC®? / Cosa prendi con una BIC®?



FACT BIC products and inks comply with European and International product safety laws and standards.
BENEFIT: You can be confident you are promoting a product from a company where safety is a fundamental priority.



FACT Click your BIC® 10,000 times.
BENEFIT: You get high quality performance backed by BIC's Product Performance Policy



FACT Clips designed to withstand up to 6,8 kg of force without breaking.
BENEFIT: Ensures durability backed by BIC's Product Performance Policy.



FACT Write performance tests are conducted.
BENEFIT: High quality cartridges with no gooping or skipping.



FACT Durable tungsten carbide ball – the only substance harder is diamond.
BENEFIT: Contributes to consistent writing.



Point Fort: Les produits et les encres BIC® sont conformes aux lois et standards européens et internationaux sur la sécurité des produits.
Avantage: Vous pouvez être sûr d'utiliser un produit promotionnel fabriqué par une entreprise qui fait de la sécurité une priorité fondamentale.



Hecho: Los productos y tintas BIC® cumplen con las leyes y estándares de seguridad de producto europeos e internacionales.
Beneficio: Puede estar seguro que está promocionando un producto de una compañía en la cual la seguridad es una prioridad fundamental.



Fakt: BIC® Produkte und Tintenpatronen erfüllen die europäischen und internationalen Produktsicherheitsanforderungen und -standards.
Ihr Vorteil: Sie werben mit einem Produkt, bei dem Sicherheit an erster Stelle steht.



Caratteristica: I prodotti e gli inchiostri BIC® sono conformi ai parametri stabiliti dalla Comunità Europea in materia di standard e legislazione.
Beneficio: puoi essere sicuro che stai promuovendo prodotti provenienti da una azienda dove la sicurezza è un parametro fondamentale.



Point Fort: Actionez 10000 fois votre BIC®.
Avantage: vous avez un rendement de haute qualité, en ligne avec la politique BIC® sur la performance des produits.



Hecho: Pulse su BIC® 10.000 veces.
Beneficio: Obtendrá una alta calidad de rendimiento respaldado por la Política de Rendimiento de Producto BIC®.



Fakt: Der BIC®-Druckmechanismus kann bis zu 10.000 Mal getätigt werden.
Ihr Vorteil: Sie profitieren von einem qualitativ hochwertigen Produkt, dank unseren Richtlinien für Qualität und Produktleistung.



Caratteristica: Clicca la tua BIC 10.000 volte.
Beneficio: ottieni performance di alta qualità supportate dalla Politica di rendimento del prodotto BIC®.



Point Fort: Les clips sont conçus pour résister à une force de 6.8 kg sans casser.
Avantage: Assure une durabilité en ligne avec la politique BIC® sur la performance des produits.



Hecho: Los clips están diseñados para soportar 6,8 kg de peso sin romperse.
Beneficio: Aseguramos durabilidad, respaldado por la Política de Rendimiento de Producto BIC®.



Fakt: Die Clips können einem 6,8 kg starkem Druck ausgesetzt werden, ohne zu brechen.
Ihr Vorteil: Lange Lebensdauer dank unseren Richtlinien für Qualität und Produktleistung.



Caratteristica: Clips disegnate appositamente per resistere fino a 6,8 Kg di forza senza rottura
Beneficio: longevità supportata dalla Politica di rendimento del prodotto BIC®.



Point Fort: Les produits passent des tests de rendement de l'écriture.
Avantage: Des cartouches d'encre de haute qualité



Hecho: Los productos pasan por pruebas de rendimiento de escritura.
Beneficio: Cartuchos de alta calidad.



Fakt: Schreibleistungstests werden regelmäßig durchgeführt.
Ihr Vorteil: Tintenpatronen höchster Qualität, für garantierten Schreibkomfort.



Caratteristica: I prodotti sono sottoposti a test per la qualità di scrittura
Beneficio: alta qualità dell'inchiostro che non salta e non lascia sbavature



Point Fort: Bille résistante en carbure de tungstène – la seule substance plus résistante est le diamant.
Avantage: Contribue à une écriture régulière



Hecho: Resistente punta de tungsteno – la única sustancia más resistente es el diamante.
Beneficio: Contribuye a una escritura consistente.



Fakt: Kugel aus Wolframkarbid – nur Diamanten sind härter.
Ihr Vorteil: Gleichmäßige Schrift.



Caratteristica: Sfera durevole in carburo di tungsteno – l'unica sostanza più durevole è il diamante.
Beneficio: contribuisce ad ottenere una scrittura consistente



The engine that Drives our products

All BIC® inks are assessed according to European regulations 1999/45/EC by an independent expert and undergo a toxicological review in the US by the Duke University Medical Center under the WIMA (Writing Instrument Manufacturers Association) or ACMI (Art and Creative Materials Institute, Inc.) certification programs. The Duke review considers both the acute health effects (from skin contact, ingestion and inhalation) and the chronic health effects of the inks.

Our ink cartridges are analyzed for up to three years to test shelf life and write-out times. To ensure quality and performance, all cartridges are date stamped. For most BIC® writing instruments, we have full in-house cartridge manufacturing which includes four controls per day – viscosity, pH, humidity rate and writing quality.

Components of our cartridges are produced by the highest quality cartridge manufacturers from all over the world. Points are stainless steel, brass or nickel silver. Balls are tungsten carbide, which contributes to consistent writing. Many of our items are refillable, which gives you the ability to use over and over again.



BIC® Easy-Glide Ink™: This exclusive ink technology offers 35% smoother and bolder ink than our current ballpoint. It writes with fluid lines and no smearing! It writes with fluid lines and no smearing! Available in selected BIC® writing instruments. BIC® Round Stic® pens include a clear cartridge tube and natural support. All other items include a white cartridge tube and nickel silver point.



Gel: Offers smooth, fluid writing. Gel options available on select BIC® writing instruments



M (Medium)



F (Fine)

Ballpen: The most popular writing instrument ink system. Available in fine point on select items.



R

Roller: Similar in construction to a ballpoint but uses a smoother ball and more fluid ink.



FS

Finestyle: Felt tip roller pen.



FP

Fountain Pen: Contains an internal reservoir of water based liquid ink. Available on select Sheaffer® products.



HL

Highlighter: Our highlighter inks are water-based, and chisel tips allow for broad-line or fine-line underlining.



MK

Marker: Our permanent marking products include acid-free* ink.



P

Pencil: Includes #2 graphite lead.



MP

Mechanical Pencil: Available in 0.7 mm leads. Includes #2 graphite lead that advances quickly and easily. Select products include three 0.7 mm leads which provides write-out equivalent to 2 1/2 wood case pencils.



Le moteur qui impulse nos produits

Toutes les encres BIC® sont évaluées conformément aux réglementations européennes 1999/45/EC par un expert indépendant et subissent un examen toxicologique aux États-Unis, mené par le centre médical universitaire « Duke University Medical Center » en vertu des programmes de certification de la WIMA (Association des Fabricants d'Instruments d'Écriture) ou de l'ACMI Inc. (Institut des Produits Artistiques et Créatifs). L'examen effectué par l'Université Duke tient compte tant des effets aigus sur la santé (par contact cutané, ingestion et inhalation) que des effets chroniques sur la santé occasionnés par les encres. Nos cartouches d'encre sont analysées pendant une période pouvant aller jusqu'à trois ans pour vérifier leur durée limite de stockage et d'efficacité d'écriture. Afin de garantir leur qualité et leur performance, toutes les cartouches comportent un horodatage. Pour la plupart des instruments d'écriture BIC®, nous disposons d'une fabrication intégrale en interne des cartouches, comportant quatre contrôles par jour – viscosité, pH, hygrométrie et qualité d'écriture. Les composants de nos cartouches sont produits par les meilleurs fabricants de cartouche, en termes de qualité, à travers le monde. Les pointes sont en inox, en laiton ou en nickel-argent. Les billes sont en carbure de tungstène, ce qui contribue à une écriture cohérente. Beaucoup de nos articles sont rechargeables, ce qui vous donne la possibilité de les réutiliser aussi longtemps que vous le voulez.

BIC® Easy-Glide Ink™:

Cette technologie d'encre exclusive offre une encre qui est 35 % plus lisse et plus épaisse que notre stylo à bille actuel, permettant une écriture fluide et sans bavure ! Disponible dans la gamme prestige d'instruments d'écriture BIC. Les stylos BIC® Round Stic® comportent un tube porte cartouche transparent et un support naturel. Tous les autres articles comportent un tube porte cartouche blanc et une pointe en nickel-argent.

- Gel:** Permet une écriture lisse et fluide. Options Gel disponibles sur BIC® Intensity® Gel Clic.
- Stylo à bille:** Le système d'encre pour instruments d'écriture le plus populaire. Disponible en pointe fine sur des articles de choix.
- Roller:** De construction similaire à un stylo à bille, il utilise une bille moins dure et une encre plus fluide.
- Feutre pointe fine:** Stylo roller pointe feutre.
- Stylo-plume:** Contient un réservoir intégré d'encre liquide à base aqueuse. Disponible sur la gamme prestige de produits Sheaffer®.
- Surligneurs:** Nos encres pour surligneurs sont à base aqueuse et les pointes en biseau permettent un surlignage en trait épais ou fin.
- Marquage:** Nos produits de marquage permanent contiennent une encre non acide*.
- Crayons:** Renferment une mine en graphite #2B.
- Porte-mine:** Disponible pour mines de 0,7 mm. Contient une mine en graphite #2 à avance rapide et facile. Produits de choix comportant trois mines de 0,7 mm qui assurent un potentiel d'écriture équivalent à 2 crayons de bois 1/2.

*Sans acide ajouté ni p.H. mesurable.

Was unsere Produkte zum "Schreiben" bringt

Alle BIC® Tinten werden von einem unabhängigen Expertenteam laut den Europäischen Bestimmungen 1999/45/EC bewertet und einer toxikologischen Prüfung vom Medizinzentrum der Duke Universität entsprechend den WIMA- (Writing Instrument Manufacturers Association - Verbund der Schreibgerätenhersteller) oder ACMI- (Art and Creative Materials Institute, Inc. - Institut für Kunst- und Kreativmaterialien) Zertifizierungsprogrammen unterzogen. Die Duke-Prüfung berücksichtigt gleichermaßen akute und chronische Gesundheitsfolgen dieser Tinten (verursacht durch Hautkontakt, Einnahme und Einatmung). Unsere Tintenpatronen werden bis zu dreijährigen Tests unterzogen, um ihre Haltbarkeits- und Lebensdauer zu überprüfen. Um ihre Qualität und Leistung sicher zu stellen, werden alle Tintenpatronen mit dem Produktionsdatum versehen. Die Patronen fast aller BIC® Schreibgeräte werden in eigener Produktion hergestellt und täglich vier unterschiedlichen Kontrollen ausgesetzt – Viskosität, pH-Wert, Feuchtigkeitsgrad und Schreibqualität. Patronenkomponenten höchster Qualität werden von unseren weltweiten Partnern hergestellt. Gleichmäßiges Schreiben wird durch Spitzen aus Edelstahl, Messing oder Neusilber und einer Kugel aus Wolfrankarbid garantiert. Viele unserer Produkte sind nachfüllbar; sie können immer wieder verwendet werden.

BIC® Easy-Glide Ink™:

BIC® Easy-Glide Ink™: Diese exklusive Technologie bietet eine um 35% feinere und präzisere Tinte als unsere derzeitige Mine: gleichmäßiges Schreiben ohne Verschmieren ist jetzt garantiert! Optional erhältlich für bestimmte BIC® Schreibgeräte. Alle Kugelschreiber der BIC® Round Stic® Kategorie haben eine transparente Mine ohne Feder. Alle anderen Modelle sind mit weißer Mine sowie einer Spitze aus Neusilber ausgestattet.

- Gel:** Für feines, gleichmäßiges Schreiben. Die Gel-Option ist nur BIC® Intensity® Gel Clic erhältlich.
- Kugelschreiber:** Die beliebteste Schreibausführung. Erhältlich auch mit feiner Spitze für Select Schreibgeräte.
- Roller:** Kugelschreiber-ähnliche Ausführung mit einer weicheren Kugel und flüssigerer Tinte.
- Fineliner:** Roller feinschreibend.
- Füllfeder:** Beinhaltet eine Patrone mit flüssiger Tinte auf Wasserbasis. Erhältlich für ausgesuchte Sheaffer® Produkte.
- Leuchtmarker:** Auf Wasserbasis und mit einer speziell geformten Spitze sind sowohl breite als auch dünne Linien möglich.
- Permanent Marker:** Mit säurefreier* Tinte.
- Bleistift:** Beinhaltet #2 Graphitminen.
- Druckbleistift:** Erhältlich mit 0,7 mm Minen. Die #2 Graphitminen garantieren ein gleichmäßiges, angenehmes Schreiben. Die Select Produkte werden mit drei 0,7 mm Minen geliefert – Schreibdauer entspricht 2 ½ Holzbleistiften.

* Ohne Zusatzsäure oder messbaren p.H.-Wert.

El motor que impulsa nuestros productos

Todas las tintas BIC® son evaluadas según las normas europeas 1999/45/EC por parte de un experto independiente y son sometidas a una revisión toxicológica en Estados Unidos por parte del Centro Médico de la Universidad de Duke bajo los programas de certificación de la WIMA (Writing Instrument Manufacturers Association) o el ACMI (Art and Creative Materials Institute, Inc.). La revisión de Duke tiene en cuenta tanto los efectos graves de las tintas para la salud (por el contacto con la piel, la ingestión y la inhalación) como los efectos crónicos. Nuestros cartuchos de tinta se analizan durante períodos de hasta tres años para probar la longevidad y los tiempos de capacidad de escritura. Para garantizar su calidad y rendimiento, todos los cartuchos llevan impresa la fecha. Para la mayor parte de los instrumentos de escritura BIC®, realizamos la fabricación de los cartuchos por completo en nuestras instalaciones, lo que incluye la realización de cuatro controles diarios: viscosidad, pH, índice de humedad y calidad de escritura. Los componentes de nuestros cartuchos son producidos por los fabricantes de cartuchos con los niveles de calidad más elevados de todo el mundo. Las puntas están hechos de acero inoxidable, latón o alpaca. Las bolas son de carburo de tungsteno, que contribuye a lograr una escritura consistente. Muchos de nuestros artículos se pueden recargar, lo que le ofrece la posibilidad de utilizarlos una y otra vez.

BIC® Easy-Glide Ink™:

Tinta BIC® Easy-Glide Ink™: Esta exclusiva tecnología de tinta ofrece una tinta un 35% más ligera e intensa que la de nuestros bolígrafos actuales. Escribe con líneas fluidas y no se emborrona. Está disponible en instrumentos de escritura BIC® seleccionados. Los bolígrafos BIC® Round Stic® incluyen un tubo de cartucho transparente y un apoyo natural para los dedos. Todos los demás artículos incluyen un tubo de cartucho blanco y punta de alpaca.

- Gel:** Ofrece una escritura suave y fluida. La opción de gel está disponible en instrumentos de escritura BIC® Intensity® Gel Clic.
- Bolígrafo:** El sistema de tinta para instrumentos de escritura más popular. Disponible en punta fina en artículos seleccionados.
- Roller:** De construcción similar a un bolígrafo, pero utiliza una bola más suave y tinta más fluida.
- Escritura fina:** Rotulador.
- Pluma:** Contiene un depósito interno de tinta líquida con base acuosa. Disponible en productos Sheaffer® seleccionados.
- Rotulador:** Nuestras tintas para rotuladores son de base acuosa, y las puntas con forma de cincel permiten realizar una línea ancha o un subrayado con línea fina.
- Marcador:** Nuestros productos marcadores permanentes incluyen tinta libre de ácido*.
- Lápiz:** Incluye mina de grafito 2B.
- Portaminas:** Disponible con minas de 0,7 mm. Incluye minas de grafito del n.º #2 que avanzan de forma rápida y sencilla. Los productos seleccionados incluyen tres minas de 0,7 mm que proporcionan una capacidad de escritura equivalente a 2 1/2 lápices de madera.

*Sin adición de ácido o pH medible.

Il motore che guida i nostri prodotti

Tutti gli inchiostri BIC® sono sottoposti da un laboratorio esterno ai test che assicurano la conformità con i regolamenti Europei 1000/45/EC e ad una revisione tossicologica in USA dal Duke University Medical Center sotto il WIMA (Writing Instrument Manufacturers Association) o ACMI (Art and Creative Materials Institute, Inc.) programma di certificazione. La revisione Duke considera tutti gli effetti acuti sulla salute (dal contatto con la pelle, all'ingerimento o inalazione) e gli effetti cronici sulla salute degli inchiostri. I nostri refill sono testati per durare fino a 3 anni, tempo per il quale il prodotto può essere commercializzato. Al fine di assicurare qualità e rendimento, tutte le cartucce hanno la data di produzione stampata. Per la maggior parte dei prodotti da scrittura BIC® i refill che abbiamo in stock subiscono sino a 4 controlli al giorno – viscosità, pH, umidità e qualità della scrittura. I componenti delle nostre cartucce sono prodotti con i più alti parametri di qualità presenti nelle fabbriche in tutto il mondo. Le punte sono in acciaio satinato, ottone o silver nickel. Le sfere sono in carburo di tungsteno che contribuisce ad ottenere una scrittura consistente. Molti dei nostri prodotti sono ricaricabili, il che garantisce la possibilità di essere utilizzati più e più volte.

BIC® Easy-Glide Ink™:

BIC® Easy-Glide Ink™: questa esclusiva tecnologia di inchiostro offre il 35% di morbidezza in più e un tratto più grosso rispetto alle penne abituali. Scrivono con una linea fluida e non macchiano. Disponibili per una selezione di prodotti BIC®. Le penne BIC® Round Stic® includono il refill trasparente. Tutti gli altri prodotti includono il refill bianco con la punta in silver nickel.

- Gel:** scrittura fluida e morbida. L'opzione Gel è disponibile per BIC® Intensity® Gel Clic.
- Sfera:** l'inchiostro più popolare. Disponibile in punta fine per alcuni prodotti.
- Roller:** Simili nella struttura della punta ma impiega una sfera più morbida e un inchiostro più fluido.
- Finestyle:** Punta in feltro.
- Stilografica:** contiene un serbatoio interno di acqua. Disponibile per alcuni prodotti Sheaffer®.
- Evidenziatori:** a base d'acqua, la punta obliqua permette la sottolineatura larga o fine.
- Pennarelli:** I nostri pennarelli permanenti includono un inchiostro acid-free*.
- Matite:** durezza mina 2B.
- Portamine:** disponibile con mina 0,7 mm 2b che permette una scrittura veloce e facile.

*Non contiene prodotti chimici ed il pH non è misurabile.

Please refer to the inside front cover for icon definitions.



What is BIC® Fraud Defense Ink™?



BIC® Fraud Defense Ink™ is available for these popular products...

This ballpoint ink provides a durable defense against **check or prescription fraud**.

What is check or prescription washing?

Common household solvents can be used to literally "wash" away the writing ink that appears on checks and prescriptions. This enables others to rewrite checks or prescriptions, usually for fraudulent purposes.

BIC® Fraud Defense Ink™ is formulated to be **water-resistant, light-resistant and eraser-resistant** to help protect your secure documents. This ballpoint ink is a great product for the financial, insurance and general business markets.

BIC® Fraud Defense Ink™ adheres to ISO 12757-1 and 12757-2 standards for ballpoint pens and refills for general and document use. These include tests for the resistance of UV, water, eraser, ethanol, bleaching, hydrochloric acid, ammonium hydroxide and acetone. Let BIC® Graphic Europe help you stay safe and secure by protecting your important documents with BIC® Fraud Defense Ink™.



BIC® Media Clic Items

BIC® Ecolutions™ Media Clic™

Helps prevent check and /or prescription fraud



BIC® Media Clic Grip Items

BIC® Media Clic Grip Digital, BIC® Ecolutions™ Media Clic® Grip, BIC® Ecolutions™ Media Clic® Grip Digital

Fast drying



BIC® Media Clic Premium Item

Light-resistant (Does not fade in direct sunlight)



BIC® Clic Stic™ Items

BIC® Ecolutions™ Clic Stic®, BIC® Soft Feel®, BIC® Ecolutions™ Clic Stic® Digital

Eraser-resistant



BIC® Pivo® Items

Smudge-resistant



BIC® Wide Body® Items

BIC® Wide Body® Digital, BIC® Ecolutions™ Wide Body®, BIC® Ecolutions™ Wide Body® Digital

Water-resistant



BIC® Media Max Items

BIC® Media Max Digital, BIC® Ecolutions™ Media Max, BIC® Ecolutions™ Media Max Digital

Great for any business including financial, insurance, or medical markets.



BIC® Media Max Premium Items

BIC® Media Max Premium Digital



BIC® Clic Items

BIC® Clic & BIC® Clic Gold



BIC® Citation™

Please look for the BIC® Fraud Defense Ink™ icon on the individual product pages.



Qu'est-ce que l'encre infalsifiable BIC® Fraud Defense Ink™?

Cette encre pour stylo à bille assure une protection durable contre la fraude pour les chèques ou ordonnances.







En quoi consiste la falsification de chèque ou d'ordonnance par lavage?

Les solvants ménagers courants peuvent être utilisés pour délayer l'encre d'écriture apparaissant sur les chèques et les ordonnances. Ceci permet alors à des tiers de réécrire les chèques ou ordonnances, généralement à des fins frauduleuses.

L'encre BIC® Fraud Defense™ est formulée de manière à être à l'épreuve de l'eau, résistante à la lumière et à l'effacement afin de mieux protéger vos documents sécurisés. Cette encre pour stylo à bille est le produit idéal pour le marché des entreprises financières, d'assurance et généralistes.

L'encre BIC® Fraud Defense™ respecte les normes ISO 12757-1 et 12757-2 pour les stylos à bille et leurs recharges à usage général et documentaire. Ces dernières comprennent des essais portant sur la résistance aux UV, à l'eau, à l'effacement, à l'éthanol, au blanchiment, à l'acide chlorhydrique, à l'ammoniaque et à l'acétone. Faites confiance à BIC Graphic Europe pour vous garantir une pleine et entière sécurité en protégeant vos documents importants avec l'encre BIC® Fraud Defense™.

L'encre BIC® Fraud Defense Ink™ est disponible pour ces produits vedettes (pg.62)

-  Contribue à prévenir la falsification des chèques et/ou ordonnances
-  Séchage rapide
-  Résistant à la lumière (ne s'estompe pas à la lumière solaire directe)
-  Résistant à l'effacement par gommage
-  Anti-empreinte
-  A l'épreuve de l'eau
-  Idéal pour toute entreprise, y compris sur le marché de la finance, de l'assurance ou encore médical.

Pensez à vérifier la présence de l'icône symbolisant l'encre BIC® Fraud Defense Ink™ sur la page de présentation des produits individuels.

¿Qué es BIC® Fraud Defense Ink™?







Esta tinta de bolígrafo proporciona una defensa duradera contra el fraude en cheques o recetas médicas.

¿En qué consiste el lavado de cheques o recetas médicas?

Los disolventes domésticos comunes se pueden utilizar para "lavar" literalmente la tinta escrita que aparece en cheques y recetas médicas. Este procedimiento permite reescribir los cheques o recetas, normalmente con fines fraudulentos.

La tinta BIC® Fraud Defense Ink™ está formulada para que sea resistente al agua y a la luz y a los borradores para ayudarle a proteger sus documentos importantes. Esta tinta de bolígrafo es un producto excelente para los sectores financiero y de seguros, y para las empresas en general. BIC® Fraud Defense Ink™ cumple las normas ISO 12757-1 y 12757-2 para bolígrafos y recargas para uso general y en documentos. Estas normas incluyen pruebas de resistencia a rayos ultravioleta, agua, borrador, etanol, lejía, ácido clorhídrico, hidróxido amónico y acetona. BIC Graphic Europe le puede ayudar a preservar su seguridad protegiendo sus documentos importantes con BIC® Fraud Defense Ink™.

BIC® Fraud Defense Ink™ está disponible en estos populares productos (pg.62)

-  Ayuda a impedir el fraude en cheques o recetas médicas
-  Se seca rápidamente
-  Resistente a la luz (no se difumina bajo la luz directa del sol)
-  Resistente a goma de borrar
-  No mancha
-  Resistente al agua
-  Está indicada para todos los sectores empresariales, como el financiero, el de seguros o el médico

Busque el icono de BIC® Fraud Defense Ink™ en las páginas de los productos individuales.

Was ist BIC® Fraud Defense Ink™?

Diese Kugelschreibermine garantiert dauerhaften Schutz gegen Scheckbetrug und Dokumentenfälschung.

Was ist Scheckbetrug oder Dokumentenfälschung?







Übliche Haushaltslösungsmittel können verwendet werden, um die Scheck- oder Dokumentenschreibfarbe buchstäblich zu "waschen". Die umgeschriebenen Schecks / Dokumente können dann zu betrügerischen Zwecken verwendet werden.

Die wasserfeste, lichtbeständige und wischfeste Formel schützt Ihre wichtigen Dokumente. Finanz- und Versicherungsunternehmen können besonders davon profitieren.

Die BIC® Fraud Defense Ink™ entspricht der ISO 12757-1 und 12757-2 Normen für den allgemeinen und Dokumenten Gebrauch der Kugelschreibermine. Getestet werden die UV-Beständigkeit, Wasser- und Wischfestigkeit sowie den zulässigen Inhalt an Äthanol, Bleichmittel, Chlorwasserstoffsäure, Ammoniumhydroxid und Aceton.

Mit der BIC® Fraud Defense Ink™ helfen wir Ihnen, Ihre wichtigen Dokumente zu schützen!

BIC® Fraud Defense Ink™ ist für folgende Produkte erhältlich (pg.62)

-  Schutz gegen Scheckbetrug und Dokumentenfälschung
-  Schnell-trocknend
-  Lichtbeständig (färbt nicht ab bei direktem Sonnenlicht)
-  Wischfest
-  Schmierfrei
-  Wasserfest
-  Ideal in allen Branchen inkl. Finanz-, Versicherungs- und Pharmaunternehmen.

Suchen Sie das BIC® Fraud Defense Ink™ Symbol auf den einzelnen Produktseiten!

Cos'è l'inchiostro BIC® Fraud Defense Ink™?

Questa inchiostro per penna a sfera assicura una duratura difesa contro le frodi.







Che cosa si intende per "sbiadire" un assegno o una ricetta medica?

I comuni solventi casalinghi possono essere utilizzati per "lavare" letteralmente gli inchiostri standard su assegni o ricette mediche. Ciò permette ad altri di riscrivere sopra gli assegni, normalmente per scopi fraudolenti.

BIC® Fraud Defense Ink™ è specificatamente formulato per essere resistente all'acqua, alla luce e anti cancellatura, al fine di proteggere e rendere più sicuri i tuoi documenti. Questa penna a sfera è un prodotto innovativo particolarmente indicato per i settori finanziari, bancari e assicurativi.

BIC® Fraud Defense Ink™ è conforme agli standard ISO 12757-1 e 12757-2 per le penne e i refill per utilizzi generali. Ciò include test per la resistenza ai raggi UVA, acqua, cancellature, etanolo, candeggio, acido cloridrico, idrossido di ammonio e acetone. Permetti a BIC Graphic Europe di aiutarti a garantire la sicurezza e la protezione dei tuoi documenti più importanti.

L'inchiostro BIC® Fraud Defense Ink™ è disponibile per tutti questi prodotti (pg.62)

-  Aiuta a prevenire le frodi
-  Asciugatura rapida
-  Resistente alla luce (non si scolorisce con l'esposizione diretta al sole)
-  Resistente alle cancellature
-  Anti sbavatura
-  Resistente all'acqua
-  Adatto per ogni tipo di business, soprattutto finanziario, assicurativo e medico

Cerca l'icona del BIC® Fraud Defense Ink™ nelle pagine di ogni singolo prodotto.

BIC® Select BIC® Select BIC® Select BIC® Select BIC® Select

BIC® Slim Metal	66	BIC® Attriant®	72
BIC® Rondo Style	67	BIC® Tri-Tone Twist	73
BIC® Wide Body™ Metal.	68	BIC® Steel™ Ballpen	74
BIC® Wide Body™ Metal Grip	69	BIC® Steel™ Roller	75
BIC® Pivo® Metal.	70	BIC® Steel™ Retractable.	76
BIC® Protrusion Grip.	71	BIC® Rubi	77



Jones
International

International

International

International

International

Jones
International

Jones

Jones

Jones



Barrel / Ink



BIC® Slim Metal:
(1,1 cm W x 13,7 cm H)

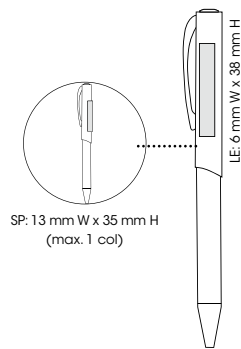

1927 Ballpen / Bille / Bolígrafo / Kugelschreiber / Sfera

- Nice curved clip design
- Shiny nickel, satin chrome attributes
- Metallic finish

Imprint

SP: cap 1 colour
LE: cap 1 colour
(90° to Clip)

- Clip au design incurvé
- Attributs en chrome satiné et nickel brillant
- Fini métallisé

Impression

SP: capuchon 1 couleur
LE: capuchon 1 couleur
(90° du Clip)

- Bonito diseño curvado del clip
- Niquelado brillante, atributos cromados satinados
- Acabado metálico

Impresión

SP: capuchón 1 color
LE: capuchón 1 color
(90° al Clip)

- Gebogenes Clip-Design
- Beschläge vernickelt und poliert
- Metallic-Finish

Personalisierung

SP: Kappe 1 Farbe
LE: Kappe 1 Farbe
(90° zum Clip)

- Design gradevole con clip ricurva
- Nickel lucido, particolari cromo satinati
- Metallizzata

Stampa

SP: cappuccio 1 colore
LE: cappuccio 1 colore
(90° dalla Clip)

Barrel / Ink Rubberized



Classic



BIC® Rondo Style:
(1,1 cm W x 13,7 cm H)

Rubberized

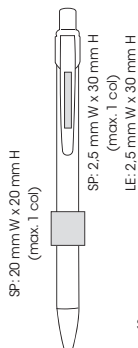

Classic

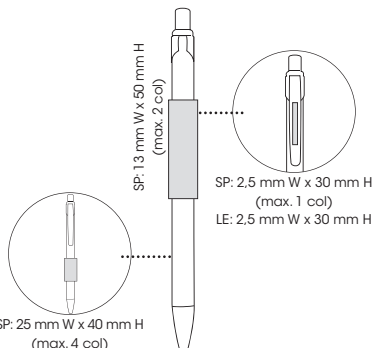

BIC® Rondo Style Rubberized Ballpoint

1275 Ballpen / Bille / Bolígrafo / Kugelschreiber / Sfera

BIC® Rondo Style Classic Ballpoint

1274 Ballpen / Bille / Bolígrafo / Kugelschreiber / Sfera



BIC® Rondo Style
Rubberized Ballpoint

BIC® Rondo Style
Classic Ballpoint

- Classic and elegant style with soft rubberized barrel
- Contemporary design

- Style classique et élégant avec corps en caoutchouc
- Design contemporain

- Cuerpo elegante con un estilo clásico y aterciopelado
- Diseño contemporáneo

- Klassischer und eleganter Stil mit einem gummiertem Schaft
- Modernes Design

- Stile classico ed elegante con morbido corpo gommato
- Design contemporaneo

Imprint

1275

SP: clip and barrel
1 colour

LE: clip 1 colour

1274

SP: barrel aligned with clip up to 4 colours, barrel opposite clip 2 colours and clip up to 1 colour
LE: clip 1 colour

Impression

1275

SP: clip et corps
1 couleur

LE: clip 1 couleur

1274

SP: Aligné sous le clip jusqu'à 4 couleurs. Si à l'opposé du clip jusqu'à 2 couleurs. Sur le clip 1 couleur.
LE: clip 1 couleur

Impresión

1275

SP: clip y cuerpo
1 color

LE: clip 1 color

1274

SP: Alineado al clip, hasta 4 colores. Contraclip 2 colores. Clip 1 color.
LE: clip 1 color

Personalisierung

1275

SP: Clip und Schaft
1 Farbe

LE: Clip 1 Farbe

1274

SP: In Verlängerung des Clips bis zu 4 Farben, gegenüber vom Clip 2 Farben und Clip 1 Farbe
LE: Clip 1 Farbe

Stampa

1275

SP: clip e corpo
1 colore

LE: clip 1 colore

1274

SP: centrato alla clip fino a 4 colori, opposto alla clip 1 colore e clip fino a 2 colori
LE: clip 1 colore

*Available from 1st May 2011 / *Disponible a partir du 1er mai 2011 / *Disponibile a partir del 1 de mayo de 2011 / *Erhältlich ab dem 1. Mai 2011 / *Disponibile dal 1 maggio 2011

Min Qty: 50 units



M

●



250 = 3,5 Kg (approx.)

Standard Packaging: Tray of 10 units
Optional Packaging: (pg 157-158)



Barrel / Ink

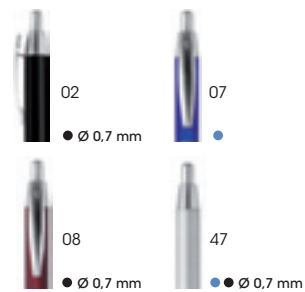

BIC® Wide Body™ Metal:
(1,1 cm W x 13,4 cm H)

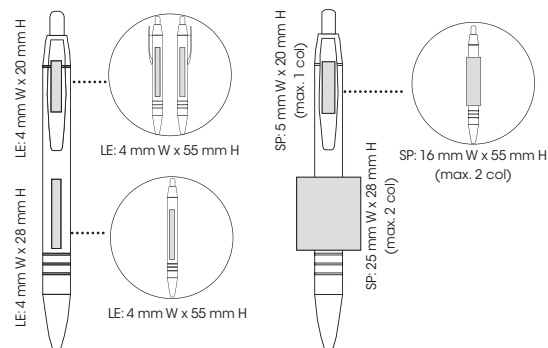

1285 Ballpen / Bille / Bolígrafo / Kugelschreiber / Sfera
1287 Mechanical Pencil / Mechanical Pencil / Porte-mines / Porta minas / Druckbleistift

- Wide-profile, all metal construction
- Satin chrome plated trim

- Modèle à profil large tout en métal
- Corps chromé satiné

- Línea ancha, todo metal
- Atributos cromados satinados

- Breiter Schaff aus Metall
- Beschläge verchromt und satiniert

- Ampio profilo, completamente in metallo
- Finiture placcate in cromo satinato

Imprint

SP: clip 1 colour / barrel up to 2 colours
LE: clip 1 colour / barrel 1 colour

Impression

SP: clip 1 couleur / corps jusqu'à 2 couleurs
LE: clip 1 couleur / corps 1 couleur

Impresión

SP: clip 1 color / cuerpo hasta 2 colores
LE: clip 1 color / cuerpo 1 color

Personalisierung

SP: Clip 1 Farbe / Schaff max. 2 Farben
LE: Clip 1 Farbe / Schaff 1 Farbe

Stampa

SP: clip 1 colore / corpo max. 2 colori
LE: clip 1 colore / corpo 1 colore



Wide Body™ Metal Grip

Grip / Ink

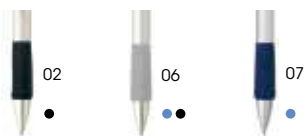

BIC® Wide Body™ Metal Grip:
(1,5 cm W x 13,4 cm H)

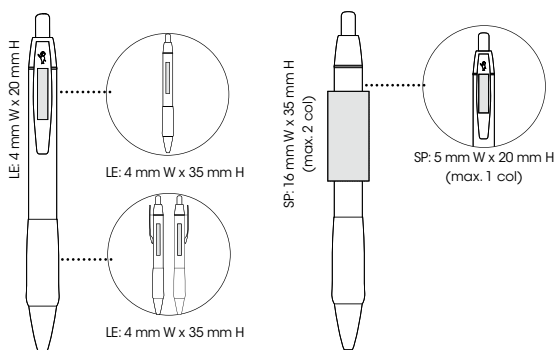

1286 Ballpen / Bille / Bolígrafo / Kugelschreiber / Sfera

• Elegance and comfort with is 3-sided grip

• Élégance et confort avec son grip à 3 côtés

• Elegancia y confort con su grip de 3 lados

• Eleganz und Schreibkomfort durch die 3-seitige Griffzone

• Eleganza e comfort con grip su 3 lati

Imprint

SP: clip 1 colour / barrel up to 2 colours
LE: clip 1 colour / barrel 1 colour

Impression

SP: clip 1 couleur / corps jusqu'à 2 couleurs
LE: clip 1 couleur / corps 1 couleur

Impresión

SP: clip 1 color / cuerpo hasta 2 colores
LE: clip 1 color / cuerpo 1 color

Personalisierung

SP: Clip 1 Farbe / Schaff max. 2 Farben
LE: Clip 1 Farbe / Schaff 1 Farbe

Stampa

SP: clip 1 colore / corpo max. 2 colori
LE: clip 1 colore / corpo 1 colore

Min Qty.: 50 units M 150 = 4,2 Kg (approx.)

Standard Packaging: Single cello bag
Optional Packaging: (pg 157-158)



pg 162

Please refer to page 4 for icon definitions.



Barrel



47



BIC® Pivo® Metal:
(1 cm W x 14,2 cm H)

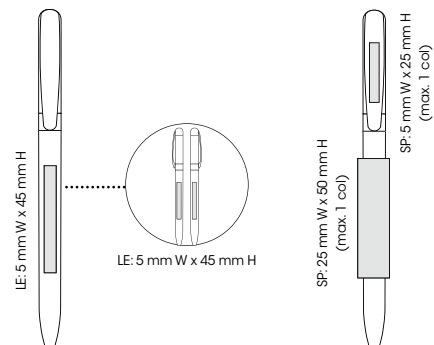

1280 Ballpen / Bille / Bolígrafo / Kugelschreiber / Sfera

- Polished silver metal finish

- Finitions en metal argenté poli

- Acabado plateado metálico pulido

- Poliertes Metallfinish

- Finiture in metallo argentato lucido

Imprint

SP: clip 1 colour /
barrel 1 colour
LE: barrel 1 colour

Impression

SP: clip 1 couleur /
corps 1 couleur
LE: corps 1 couleur

Impresión

SP: clip 1 color /
cuerpo 1 color
LE: cuerpo 1 color

Personalisierung

SP: Clip 1 Farbe /
Schaff 1 Farbe
LE: Schaff 1 Farbe

Stampa

SP: clip 1 colore /
corpo 1 colore
LE: corpo 1 colore

Barrel / Ink



BIC® Protrusion Grip:
(1,7 cm W x 13,7 cm H)

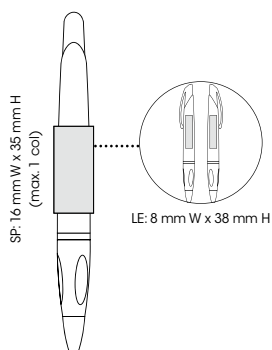

1836 Ballpen / Bille / Bolígrafo / Kugelschreiber / Sfera

- Soft protruding grip pads with polished chrome plated steel clip

- Gripsen relief avec clip en acier chromé poli

- Suave grip en relieve con clip y atributos plateados

- Profilierte Griffzone mit verchromtem Clip

- Morbida grip con gommini, clip lucida in acciaio zincato

Imprint

SP: barrel 1 colour
LE: barrel 1 colour

Impression

SP: corps 1 couleur
LE: corps 1 couleur

Impresión

SP: cuerpo 1 color
LE: cuerpo 1 color

Personalisierung

SP: Schaft 1 Farbe
LE: Schaft 1 Farbe

Stampa

SP: corpo 1 colore
LE: corpo 1 colore

Min Qty: 50 units



M



= 4,3 Kg (approx.)

Standard Packaging: Single cello bag
Optional Packaging: (pg 157-158)



pg 162

Please refer to page 4 for icon definitions.



Barrel / Ink

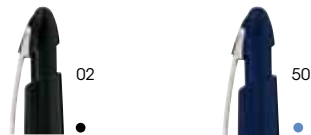

BIC® Attriant®:
(1 cm W x 14 cm H)

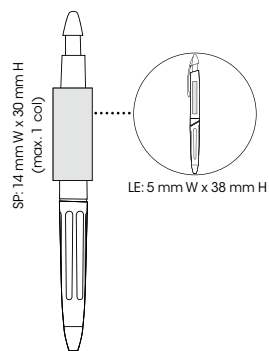

1840 Ballpen / Bille / Bolígrafo / Kugelschreiber / Sfera

- Linear patterned grip and polished chrome trim

Imprint
SP: barrel 1 colour
LE: barrel 1 colour (90° to clip)

- Grip linéaire profilé et attributs chrome poli

Impression
SP: corps 1 couleur
LE: corps 1 couleur (90° du clip)

- Grip de diseño lineal y finos atributos cromados

Impresión
SP: cuerpo 1 color
LE: cuerpo 1 color (90° al clip)

- Linear profilierte Griffzone und Beschläge aus poliertem Chrom

Personalisierung
SP: Schaft 1 Farbe
LE: Schaft 1 Farbe (90° zum Clip)

- Linea della grip modellata e finiture cromate lucide

Stampa
SP: corpo 1 colore
LE: corpo 1 colore (90° dalla clip)

**Barrel / Ink
Laquer finish**



BIC® Tri-Tone Twist:
(1,8 cm W x 13,9 cm H)

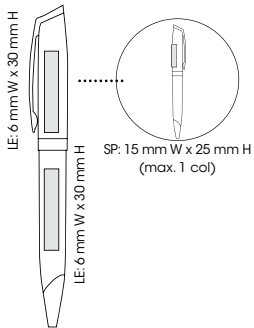

1928 Ballpen / Bille / Bolígrafo / Kugelschreiber / Sfera

- Satin chrome and nickel plated appointments
- Heavy, brass-based slanted nose cone and clip section

- Attributs en chrome satiné et nickel
- Clip et pointe en laiton

- Atributos cromado satinados y plateado niquelados
- Clip y sección macizos de latón con forma biselada

- Komponenten aus satiniertem, plattiertem Nickel
- Clip und Spitze aus massivem Messing

- Finiture cromo satinato e argento nickel
- Sezione pesante di clip in ottone e punta inclinata

Imprint

SP: cap 1 colour
LE: barrel 1 colour / cap 1 colour
(90° to Clip)

Impression

SP: capuchon 1 couleur
LE: corps 1 couleur / capuchon 1 couleur
(90° du Clip)

Impresión

SP: capuchón 1 color
LE: cuerpo 1 color / capuchón 1 color
(90° al Clip)

Personalisierung

SP: Kappe 1 Farbe
LE: Schaff 1 Farbe / Kappe 1 Farbe
(90° zum Clip)

Stampa

SP: cappuccio 1 colore
LE: corpo 1 colore / cappuccio 1 colore
(90° dalla Clip)

Min Qty.: 50 units = 4,3 Kg (approx.)

Standard Packaging: Single cello bag
Optional Packaging: (pg 157-158)



pg 162

Please refer to page 4 for icon definitions.



Barrel / Ink



47

BIC® Steel™ Ballpen:
(1,6 cm W x 13,3 cm H)

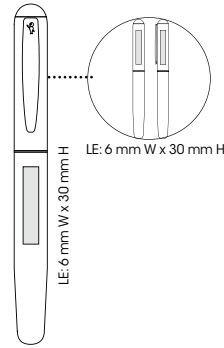

LE: 6 mm W x 30 mm H

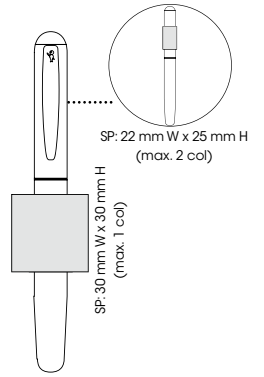

SP: 22 mm W x 25 mm H
(max. 2 col)

SP: 30 mm W x 30 mm H
(max. 1 col)

1711 Ballpen / Bille / Bolígrafo / Kugelschreiber / Sfera

- Sleek, modern design with polished chrome trim

- Design fin, moderne avec attributs chrome poli

- Fino. Diseño moderno con elegantes atributos cromados

- Modernes, glattes Design und Beschläge aus poliertem Chrom

- Design elegante e moderno, con finiture cromo lucido

Imprint

SP: barrel 1 colour / cap up to 2 colours
LE: barrel 1 colour / cap 1 colour

Impression

SP: corps 1 couleur / capuchon jusqu'à 2 couleur
LE: corps 1 couleur / capuchon 1 couleur

Impresión

SP: cuerpo 1 color / capuchón hasta 2 colores
LE: cuerpo 1 color / capuchón 1 color

Personalisierung

SP: Schaff 1 Farbe / Kappe max. 2 Farben
LE: Schaff 1 Farbe / Kappe 1 Farbe

Stampa

SP: corpo 1 colore / corpo fronte max. 2 colori
LE: corpo 1 colore / corpo fronte 1 colore

Barrel / Ink



BIC® Steel™ Roller:
(1,6 cm W x 13,3 cm H)

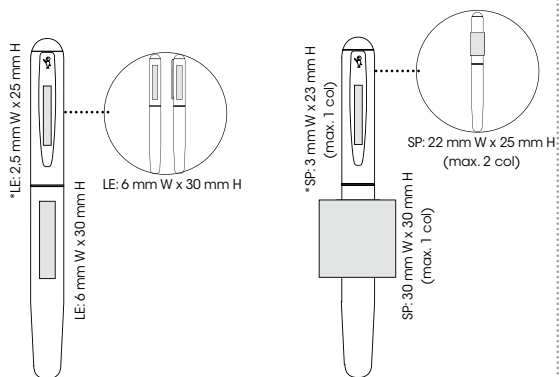

1710 Chrome Roller Ball / Stylo à bille roulante / Roller / Rollerball / Roller
1713 Color Roller Ball / Stylo à bille roulante / Roller / Rollerball / Roller



- Sleek, modern design with polished chrome trim

Imprint

SP: clip* 1 colour / barrel 1 colour / cap up to 2 colours
LE: clip* 1 colour / barrel 1 colour / cap 1 colour

*Personalisation on clip only is available for Steel Color

- Design fin, moderne avec attributs chrome poli

Impression

SP: clip* 1 couleur / corps 1 couleur / capuchon jusqu'à 2 couleur
LE: clip* 1 couleur / corps 1 couleur / capuchon 1 couleur

*La personnalisation sur le clip est disponible uniquement pour le Steel Color

- Fino. Diseño moderno con elegantes atributos cromados

Impresión

SP: clip* 1 color / cuerpo 1 color / capuchón hasta 2 colores
LE: clip* 1 color / cuerpo 1 color / capuchón 1 color

*Clip personalizado sólo disponible para Steel Color

- Modernes, glattes Design und Beschläge aus poliertem Chrom

Personalisierung

SP: Clip* 1 Farbe / Schaff 1 Farbe / Kappe max. 2 Farben
LE: Clip* 1 Farbe / Schaff 1 Farbe / Kappe 1 Farbe

* Personalisierung auf dem Clip nur für Steel Color erhältlich

- Design elegante e moderno, con finiture cromo lucido

Stampa

SP: clip* 1 colore / corpo 1 colore / corpo fronte max. 2 colori
LE: clip* 1 colore / corpo 1 colore / corpo fronte 1 colore

* Personalizzazione sulla clip disponibile solo per Steel Color

Min Qty.: 25 units



= 3,6 Kg (approx.)

Standard Packaging: Single cello bag
Optional Packaging: (pg 157-158)



pg 162

Please refer to page 4 for icon definitions.



Barrel / Ink



BIC® Steel™ Retractable:
(1,5 cm W x 13,6 cm H)

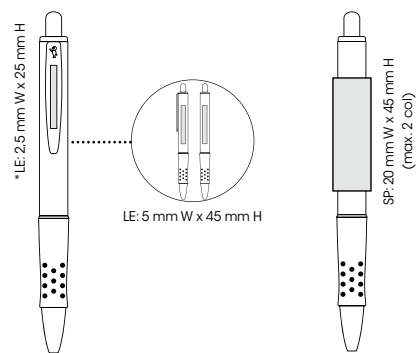

1712 Chrome Ballpen / Bille / Bolígrafo / Kugelschreiber / Sfera
1714 Colours Ballpen / Bille / Bolígrafo / Kugelschreiber / Sfera

• Soft, cushioned grip

Imprint

SP: barrel up to 2 colours
LE: clip* 1 colour / barrel 1 colour

*Personalisation on clip only is available for Steel Color

• Zone de préhension douce rembourrée

Impression

SP: corps jusqu'à 2 couleurs
LE: clip* 1 couleur / corps 1 couleur

*La personnalisation sur le clip est disponible uniquement pour le Steel Color

• Suave grip acolchado

Impresión

SP: cuerpo hasta 2 colores
LE: clip* 1 color / cuerpo 1 color

*Clip personalizado sólo disponible para Steel Color

• Weich gepolsterte Griffzone

Personalisierung

SP: Schaft max. 2 Farben
LE: Clip* 1 Farbe / Schaft 1 Farbe

* Personalisierung auf dem Clip nur für Steel Color erhältlich

• Grip morbida

Stampa

SP: corpo max. 2 colori
LE: clip* 1 colore / corpo 1 colore

* Personalizzazione sulla clip disponibile solo per Steel Color

Barrel / Ink

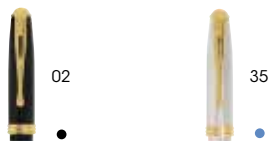

BIC® Rubi:
(1,5 cm W x 12,9 cm H)

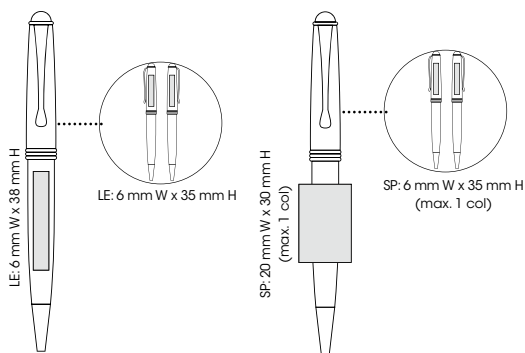

1255 Ballpen / Bille / Bolígrafo / Kugelschreiber / Sfera

1258 Ballpen / Bille / Bolígrafo / Kugelschreiber / Sfera

- Sleek, chrome plated or rich lacquer finishes with 22k gold plated trim

- Fini chromé ou laqué avec attributs en or plaqué 22 carats

- Acabados cromados en plata o laqueados con atributos bañados en oro de 22k

- Schlichtes Design in verchromter oder glänzender Ausführung mit vergoldeten Beschlägen in 22K

- Elegante, finiture cromato o placcato oro 22k

Imprint

SP: barrel 1 colour / cap 1 colour
LE: barrel 1 colour / cap 1 colour

Impression

SP: corps 1 couleur / capuchon 1 couleur
LE: corps 1 couleur / capuchon 1 couleur

Impresión

SP: cuerpo 1 color / capuchón 1 color
LE: cuerpo 1 color / capuchón 1 color

Personalisierung

SP: Schaff 1 Farbe / Kappe 1 Farbe
LE: Schaff 1 Farbe / Kappe 1 Farbe

Stampa

SP: corpo 1 colore / cappuccio 1 colore
LE: corpo 1 colore / cappuccio 1 colore

Min Qty.: 25 units M = 4,9 Kg (approx.)

Standard Packaging: Single cello bag
Optional Packaging: (pg 157-158)



pg 162

Please refer to page 4 for icon definitions.

Sheaffer® Sheaffer® Sheaffer® Sheaffer® Sheaffer® Sheaffer®

Sheaffer® Legacy® Heritage	80	Sheaffer® Agio®	85
Sheaffer® Prelude® Black Laque	81	Sheaffer® 300	86
Sheaffer® Prelude® Black Laque & Palladium Cap.	82	Sheaffer® 100	87
Sheaffer® Prelude® Brushed Chrome.	83	Sheaffer® Sentinel®	88
Sheaffer® Prelude® Brushed Chrome Gold	84	Sheaffer® Sentinel® Colors	89



SHEAFFER®



Finishes



Black laque finish cap & barrel with palladium plate trim

Sheaffer® Legacy® Heritage:
(1,3 cm W x 13,8 cm H)

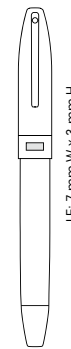

1510 Fountain Pen / Stylo Plume / Pluma / Füllfederhalter / Penna Stilografica

1512 Ballpen / Bille / Bolígrafo / Kugelschreiber / Sfera

• Over 6,300 metres of ballpoint write-out
• Sheaffer® "White Dot"® hallmark of quality and prestige
• Sheaffer® Limited Lifetime Warranty

Imprint
LE: ring 1 colour

• Plus de 6 300 mètres d'écriture (stylo bille)
• Qualité et prestige du poinçon Sheaffer® "White Dot"®
• Garantie à vie limitée Sheaffer®

Impression
LE: bague 1 couleur

• Hasta 6.300 metros de escritura ininterrumpida
• Sheaffer® "White Dot"® sello de calidad y prestigio
• Garantía limitada de por vida Sheaffer®

Impresión
LE: anilla 1 color

• Über 6.300 Meter Schreiblänge
• Sheaffer® "White Dot"® ist das Markenzeichen für Luxus, Prestige und Qualität
• Sheaffer® Garantie auf Lebenszeit limitiert

Personalisierung
LE: Ring 1 Farbe

• Oltre 3.5 miglia (6,300 metri) di scrittura
• Sheaffer® "White Dot"® marchio di garanzia di qualità e di prestigio
• Garantia vitalícia limitada Sheaffer®

Stampa
LE: anello 1 colore

Finishes



Black Laque/
Nickel plate trim



Sheaffer® Prelude® Black Laque:
(1,58 cm W x 13,3 cm H)

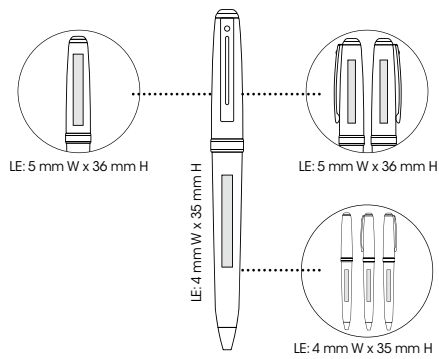

1406 Roller Ball / Stylo à bille roulante / Roller / Rollerball / Roller
1407 Ballpen / Bille / Bolígrafo / Kugelschreiber / Sfera

• Over 6,300 metres of ballpoint write-out
• Sheaffer® Limited Lifetime Warranty

• Plus de 6 300 mètres d'écriture (stylo bille)
• Garantie à vie limitée Sheaffer®

• Hasta 6.300 metros de escritura ininterrumpida
• Garantía limitada de por vida Sheaffer®

• Über 6.300 Meter Schreiblänge
• Sheaffer® Garantie auf Lebenszeit limitiert

• Oltre 3.5 miglia (6,300 metri) di scrittura
• Garanzia vitalicia limitada Sheaffer®

Imprint
LE: barrel 1 colour / cap 1 colour

Impression
LE: corps 1 couleur / capuchon 1 couleur

Impresión
LE: cuerpo 1 color / capuchón 1 color

Personalisierung
LE: Schäft 1 Farbe / Kappe 1 Farbe

Stampa
LE: corpo 1 colore / corpo fronte - 1 colore

Min Qty.: 1 units M R = 2.7 Kg (approx.)

Standard Packaging: ww30 (pg 159)
Optional Packaging: pg 159



pg 162

Please refer to page 4 for icon definitions.
Please refer to page 170 - 171 for Sheaffer® warranties.



Finishes



Sheaffer® Prelude® Black Laque / Palladium Cap:
(1,58 cm W x 13,3 cm H)

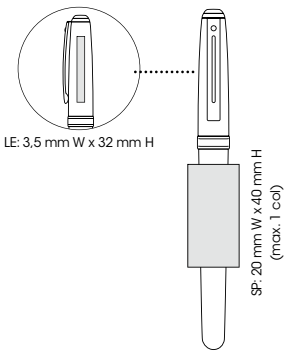

1416 Ballpen / Bille / Bolígrafo / Kugelschreiber / Sfera

- Over 6,300 metres of ballpoint write-out
- Sheaffer® Limited Lifetime Warranty

- Plus de 6 300 mètres d'écriture (stylo bille)
- Garantie à vie limitée Sheaffer®

- Hasta 6.300 metros de escritura ininterrumpida
- Garantía limitada de por vida Sheaffer®

- Über 6.300 Meter Schreiblänge
- Sheaffer® Garantie auf Lebenszeit limitiert

- Oltre 3.5 miglia (6,300 metri) di scrittura
- Garanzia vitalicia limitada Sheaffer®

Imprint

SP: barrel 1 colour
LE: cap 1 colour

Impression

SP: corps 1 couleur
LE: capuchon 1 couleur

Impresión

SP: cuerpo 1 color
LE: capuchón 1 color

Personalisierung

SP: Schaft 1 Farbe
LE: Kappe 1 Farbe

Stampa

SP: corpo 1 colore
LE: corpo fronte - 1 colore

Finishes



Brushed Chrome plate finish with chrome plate trim

● ● Ø 0,7 mm

Sheaffer® Prelude® Brushed Chrome:
(1,58 cm W x 13,3 cm H)

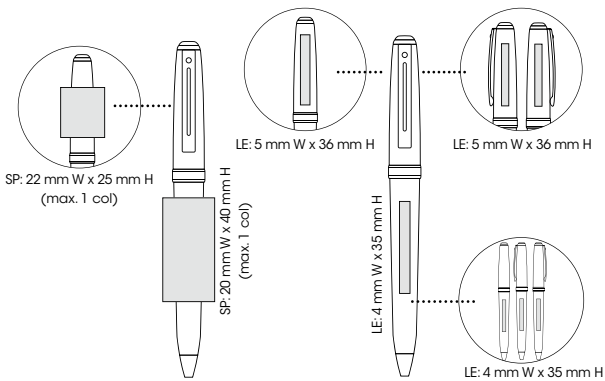

1532 Fountain Pen/ Stylo Plume / Pluma / Füllfederhalter / Penna Stilografica

1533 Roller Ball / Stylo à bille roulante / Roller / Rollerball / Roller

1534 Ballpen / Bille / Bolígrafo / Kugelschreiber / Sfera

1535 Pencil / Porte-mine/ Portaminas / Bleistift / Portamine

• Over 6,300 metres of ballpoint write-out
 • Sheaffer® Limited Lifetime Warranty

• Plus de 6 300 mètres d'écriture (stylo bille)
 • Garantie à vie limitée Sheaffer®

• Hasta 6.300 metros de escritura ininterrumpida
 • Garantía limitada de por vida Sheaffer®

• Über 6.300 Meter Schreiblänge
 • Sheaffer® Garantie auf Lebenszeit limitiert

• Oltre 3.5 miglia (6.300 metri) di scrittura
 • Garanzia vitalicia limitada Sheaffer®

Imprint

SP: barrel 1 colour / cap 1 colour
 LE: barrel 1 colour / cap 1 colour

Impression

SP: corps 1 couleur / capuchon 1 couleur
 LE: corps 1 couleur / capuchon 1 couleur

Impresión

SP: cuerpo 1 color / capuchón 1 color
 LE: cuerpo 1 color / capuchón 1 color

Personalisierung

SP: Schaft 1 Farbe / Kappe 1 Farbe
 LE: Schaft 1 Farbe / Kappe 1 Farbe

Stampa

SP: corpo 1 colore / capuccio 1 colore
 LE: corpo 1 colore / capuccio 1 colore

Min Qty.: 10 units



M ●



MP ● Ø 0,7 mm



12 = 2,7 Kg (approx.)



R ●



FP ●

Standard Packaging: ww30 (pg 159)
 Optional Packaging: pg 159



pg 162

Please refer to page 4 for icon definitions.
 Please refer to page 170 - 171 for Sheaffer® warranties.



Finishes



Chrome Gold Brushed
Chrome plate finish
with 22K gold plate trim

Sheaffer® Prelude® Brushed Chrome Gold:
(1,58 cm W x 13,3 cm H)

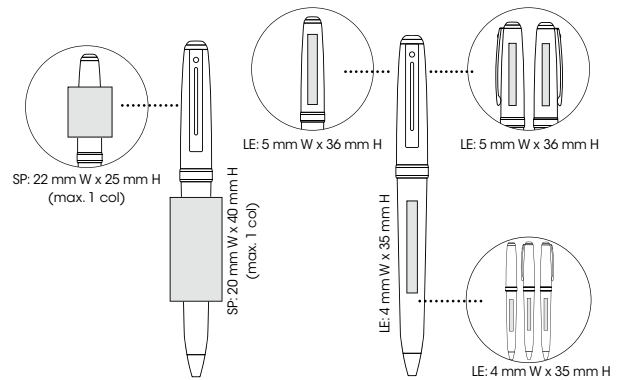

1530 Ballpen / Bille / Bolígrafo / Kugelschreiber / Sfera

- Over 6,300 metres of ballpoint write-out
- Sheaffer® Limited Lifetime Warranty

- Plus de 6 300 mètres d'écriture (stylo bille)
- Garantie à vie limitée Sheaffer®

- Hasta 6.300 metros de escritura ininterrumpida
- Garantía limitada de por vida Sheaffer®

- Über 6.300 Meter Schreiblänge
- Sheaffer® Garantie auf Lebenszeit limitiert

- Oltre 3.5 miglia (6,300 metri) di scrittura
- Garanzia vitalicia limitada Sheaffer®

Imprint

SP: barrel 1 colour / cap 1 colour
LE: barrel 1 colour / cap 1 colour

Impression

SP: corps 1 couleur / capuchon 1 couleur
LE: corps 1 couleur / capuchon 1 couleur

Impresión

SP: cuerpo 1 color / capuchón 1 color
LE: cuerpo 1 color / capuchón 1 color

Personalisierung

SP: Schaft 1 Farbe / Kappe 1 Farbe
LE: Schaft 1 Farbe / Kappe 1 Farbe

Stampa

SP: corpo 1 colore / capuccio 1 colore
LE: corpo 1 colore / capuccio 1 colore



Finishes



Sheaffer® Agio®:
(0,6 cm W x 13 cm H)

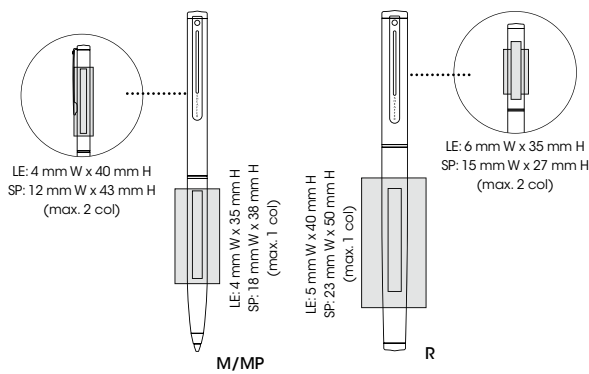

- 1540 Roller Ball / Stylo à bille roulante / Roller / Rollerball / Roller
- 1541 Ballpen / Bille / Bolígrafo / Kugelschreiber / Sfera
- 1542 Pencil / Porte-mine/ Portaminas / Bleistift / Portamine

- Slim profile writing instruments
- Thin and elegant
- Sheaffer® Limited 3 Year Warranty

- Instruments d'écriture à profil fin
- Légers et élégants
- Garantie limitée de 3 ans Sheaffer®

- Perfil fino
- Liviano y elegante
- Garantía limitada de 3 años Sheaffer®

- Schreibgeräte mit schlankem Profil
- Leicht und elegant
- 3 Jahre befristete Sheaffer® Garantie

- Penne a profilo sottile
- Leggera ed elegante
- Garantía limitada de 3 años Sheaffer®

Imprint
SP: barrel 1 colour / cap 2 colours
LE: barrel 1 colour / cap 1 colour

Impression
SP: corps 1 couleur / capuchon 2 couleurs
LE: corps 1 couleur / capuchon 1 couleur

Impresión
SP: cuerpo 1 color / capuchón 2 colores
LE: cuerpo 1 color / capuchón 1 color

Personalisierung
SP: Schaff 1 Farbe / Kappe 2 Farben
LE: Schaff 1 Farbe / Kappe 1 Farbe

Stampa
SP: corpo 1 colore / cappuccio 2 colori
LE: corpo 1 colore / cappuccio 1 colore

Min Qty.: 25 units M R MP Ø 0,7 mm = 2,6 Kg (approx.)

Standard Packaging: ww30 (pg 159)
Optional Packaging: pg 159



pg 162

Please refer to page 4 for icon definitions.
Please refer to page 170 - 171 for Sheaffer® warranties.



Finishes

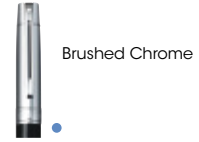
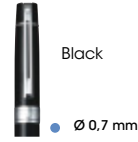

Sheaffer® 300:
(0,11 cm W x 13,5 cm H)

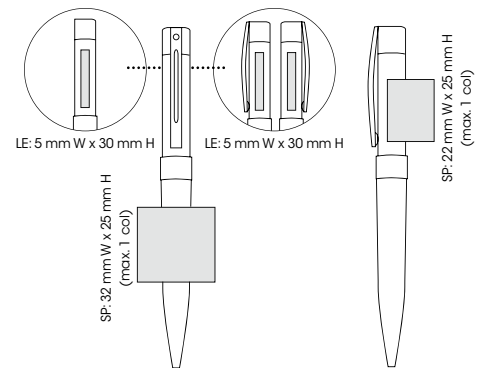

Black:

- 1556** Ballpen / Bille / Bolígrafo / Kugelschreiber / Sfera
- 1557** Pencil / Porte-mine/ Portaminas / Bleistift / Portamine

Brushed Chrome:

- 1558** Ballpen / Bille / Bolígrafo / Kugelschreiber / Sfera

- Over 6,300 metres of ballpoint write-out
- Modern design
- Sheaffer® Limited 1 Year Warranty

- Plus de 6 300 mètres d'écriture (stylo bille)
- Design moderne
- Garantie limitée Sheaffer® de 1 an

- Hasta 6.300 metros de escritura ininterrumpida
- Diseño moderno
- Garantía limitada de 1 año Sheaffer®

- Über 6.300 Meter Schreiblänge
- Modernes Design
- Ein Jahr Sheaffer® Garantie

- Oltre 3.5 miglia (6,300 metri) di scrittura
- Design moderno
- Garanzia limitata de 1 ano Sheaffer®

Imprint

SP: barrel 1 colour / cap 1 colour
LE: cap 1 colour

For Brushed Chrome, screen printing only available on the barrel.

Impression

SP: corps 1 couleur / capuchon 1 couleur
LE: capuchon 1 couleur

Modèle Chrome : sérigraphie disponible uniquement sur le corps du crayon.

Impresión

SP: cuerpo 1 color / capuchón 1 color
LE: capuchón 1 color

Para Cromo Satinado, la serigrafía sólo está disponible en el cuerpo.

Personalisierung

SP: Schaff 1 Farbe / Kappe 1 Farbe
LE: Kappe 1 Farbe

Schreibgeräte in Chrom gebürstet sind nur auf dem Schaff mit Siebdruck personalisierbar.

Stampa

SP: corpo 1 colore / cappuccio 1 colore
LE: cappuccio 1 colore

Per Cromato satinato, serigrafia disponibile solo sul corpo.

Finishes



Sheaffer® 100:
(1,5 cm W x 13,5 cm H)

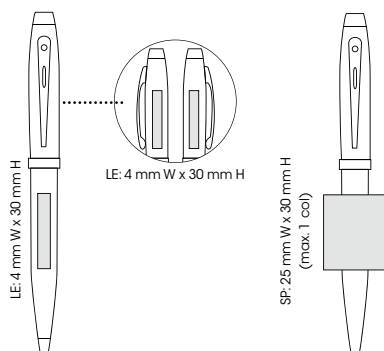

1546 Ballpen / Bille / Bolígrafo / Kugelschreiber / Sfera
1547 Pencil / Porte-mine/ Portaminas / Bleistift / Portamine

- Over 6,300 metres of ballpoint write-out
- The perfect gift for any occasion
- Modern design and attractive finishes
- Sheaffer® Limited 1 Year Warranty

- Plus de 6.300 mètres d'écriture (stylo bille)
- Le cadeau idéal en toute occasion
- Garantie limitée Sheaffer® de 1 an

- Hasta 6.300 metros de escritura ininterrumpida
- El regalo perfecto para cualquier ocasión
- Diseño moderno y acabados atractivos
- Garantía limitada de 1 año Sheaffer®

- Über 6.300 Meter Schreiblänge
- Das perfekte Geschenk für jede Gelegenheit
- Modernes Design in attraktiven Farbausführungen
- Ein Jahr Sheaffer® Garantie

- Oltre 3.5 miglia (6.300 metri) di scrittura
- Il regalo perfetto per ogni occasione
- Il design moderno e finiture attraenti
- Garanzia limitata de 1 ano Sheaffer®

Imprint
SP: barrel 1 colour
LE: barrel 1 colour / cap 1 colour

Impression
SP: corps 1 couleur
LE: corps 1 couleur / capuchon 1 couleur

Impresión
SP: cuerpo 1 color
LE: cuerpo 1 color / capuchón 1 color

Personalisierung
SP: Schaft 1 Farbe
LE: Schaft 1 Farbe / Kappe 1 Farbe

Stampa
SP: corpo 1 colore
LE: corpo 1 colore / cappuccio 1 colore

Min Qty.: 25 units M MP Ø 0,7 mm 25 = 2,9 Kg (approx.)

Standard Packaging: ww15 (pg 159)
Optional Packaging: pg 159



pg 162

Please refer to page 4 for icon definitions.
Please refer to page 170 - 171 for Sheaffer® warranties.



Finishes



Sheaffer® Sentinel®:
(1,27 cm W x 13,01 cm H)

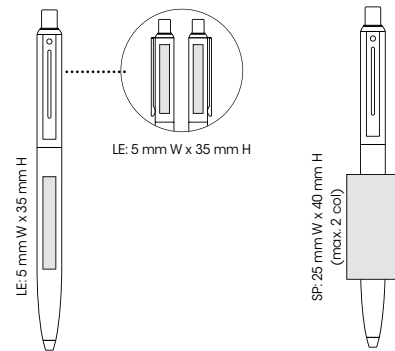

1430 Ballpen / Bille / Bolígrafo / Kugelschreiber / Sfera
1431 Pencil / Porte-mine / Portaminas / Bleistift / Portamine

• Over 6,300 metres of write out and Sheaffer® branded metal tube cartridge
• Sheaffer® Limited 1 Year Warranty

• Plus 6,300 mètres d'écriture et cartouche à tube métallique Sheaffer®
• Garantie limitée Sheaffer® de 1 an

• Hasta 6,300 metros de escritura ininterrumpida y cartucho de metal Sheaffer®
• Garantía limitada de 1 año Sheaffer®

• Über 6.300 Meter Schreiblänge - Sheaffer® - Metallmine
• Ein Jahr Sheaffer® Garantie

• Oltre 6300 metri di scrittura e refill in metallo marcato Sheaffer®
• Garanzia limitata de 1 ano Sheaffer®

Imprint
SP: barrel 2 colours
LE: barrel 1 colour / cap 1 colour

Impression
SP: corps 2 couleurs
LE: corps 1 couleur / capuchon 1 couleur

Impresión
SP: cuerpo 2 colores
LE: cuerpo 1 color / capuchón 1 color

Personalisierung
SP: Schaft 2 Farben
LE: Schaft 1 Farbe / Kappe 1 Farbe

Stampa
SP: corpo 2 colori
LE: corpo 1 colore / cappuccio 1 colore

Finishes



Sheaffer® Sentinel® Colors:
(0,95 cm W x 13 cm H)

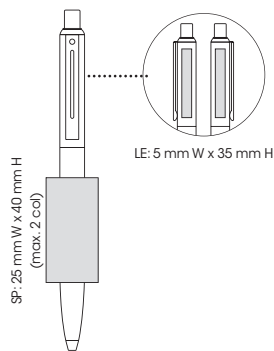

1436 Ballpen / Bille / Bolígrafo / Kugelschreiber / Sfera
1437 Pencil / Porte-mine / Portaminas / Bleistift / Portamine

• Over 6,300 metres of write out and Sheaffer® branded metal tube cartridge
• Sheaffer® Limited 1 Year Warranty

• Plus 6,300 mètres d'écriture et cartouche à tube métallique Sheaffer®
• Garantie limitée Sheaffer® de 1 an

• Hasta 6.300 metros de escritura ininterrumpida y cartucho de metal Sheaffer®
• Garantía limitada de 1 año Sheaffer®

• Über 6.300 Meter Schreiblänge - Sheaffer® - Metallmine
• Ein Jahr Sheaffer® Garantie

• Oltre 6300 metri di scrittura e refill in metallo marcato Sheaffer®
• Garanzia limitata de 1 ano Sheaffer®

Imprint
SP: barrel 2 colours
LE: barrel 1 colour / cap 1 colour

Impression
SP: corps 2 couleurs
LE: corps 1 couleur / capuchon 1 couleur

Impresión
SP: cuerpo 2 colores
LE: cuerpo 1 color / capuchón 1 color

Personalisierung
SP: Schaft 2 Farben
LE: Schaft 1 Farbe / Kappe 1 Farbe

Stampa
SP: corpo 2 colori
LE: corpo 1 colore / cappuccio 1 colore

Min Qty.: 25 units M MP Ø 0,7 mm 250 = 6,1 Kg (approx.)

Standard Packaging: Tray of 10 units
Optional Packaging: pg 159



pg 162

Please refer to page 4 for icon definitions.
Please refer to page 170 - 171 for Sheaffer® warranties.

Stickynote Stickynote Stickynote Stickynote Stickynote Sticky

BIC® 50 mm x 75 mm & 68 mm x 75 mm Adhesive Notepads	92	BIC® Flag Booklet	101
BIC® 75 mm x 75 mm Adhesive Notepads	93	BIC® 75 mm x 75 mm Booklet	102
BIC® 101mm x 75 mm Adhesive Notepads	94	BIC® 101 mm x 75 mm Booklet (NEW)	103
BIC® 101mm x 75 mm Alternating Sheet Imprint (NEW)	95	BIC® 75 mm x 75 mm Adhesive Notepad with Flag Booklet	104
BIC® 101mm x 101mm Adhesive Notepads (NEW)	96	BIC® 101 mm x 75 mm Mini Pencil Booklet	105
BIC® 101mm x 152 mm Adhesive Notepads	97	BIC® Mini Clic Stic Organizer	106
BIC® 75 mm x 75 mm Adhesive Die Cut Notepads	98	BIC® Mini Digital Clic Stic Organizer	107
BIC® 101mm x 75 mm Adhesive Die Cut Notepads	99	BIC® 75 mm x 128 mm Non-Adhesive Scratch Pad	108
BIC® 101mm x 152 mm Adhesive Beveled Notepads	100	BIC® 96 mm x 152 mm Non-Adhesive Scratch Pad	109



Sticky note





50 mm x 75 mm & 68 mm x 75 mm Adhesive Notepads



*50mm x 75mm Adhesive Notepads



**68mm x 75mm Adhesive Notepads



Paper colour

White

BIC® 50mm x 75 mm Adhesive Notepads :

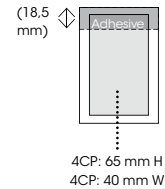

BIC® 68mm x 75mm Adhesive Notepads:

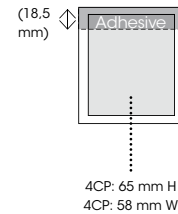

Standard paper

3522* / 3502** 25 Sheets/ Pages / Hojas / Blatt / Fogli

3552* / 3532** 50 Sheets/ Pages / Hojas / Blatt / Fogli

3582* / 3562** 100 Sheets/ Pages / Hojas / Blatt / Fogli

Recycled paper

3520* / 3500** 25 Sheets/ Pages / Hojas / Blatt / Fogli

3550* / 3530** 50 Sheets/ Pages / Hojas / Blatt / Fogli

3580* / 3560** 100 Sheets/ Pages / Hojas / Blatt / Fogli

50 mm x 75 mm Adhesive Notepads

- Affordable, pocket sized notepad

50 mm x 75 mm Adhesive Notepads

- Bloc notes adhésif économique et de petite taille

50 mm x 75 mm Adhesive Notepads

- Pequeño notepad asequible

50 mm x 75 mm Adhesive Notepads

- Kostengünstiger Haftnotizblock, unser kleinstes Format

50 mm x 75 mm Adhesive Notepads

- Prezzo accessibile, notepad di piccola dimensione

68 mm x 75 mm Adhesive Notepads

- No charge for bleeds!

68 mm x 75 mm Adhesive Notepads

- Pas de frais supplémentaires pour les impressions en couleurs vives

68 mm x 75 mm Adhesive Notepads

- ¡Sin cargo adicional por impresión a sangre (bleed)!

68 mm x 75 mm Adhesive Notepads

- Randabfallender Druck ohne Aufpreis!

68 mm x 75 mm Adhesive Notepads

- Nessun costo extra per taglio al vivo!

Imprint
4CP

Impression
4CP

Impresión
4CP

Personalisierung
4CP

Stampa
4CP

	25 sheets	50 sheets	100 sheets
Min Qty.: 500 units	= 8,7 Kg (approx.)	= 8,5 Kg (approx.)	= 8,4 Kg (approx.)
Min Qty.: 500 units	= 5,7 Kg (approx.)	= 5,4 Kg (approx.)	= 5,6 Kg (approx.)



pg 162

BIC eolutions
Recycled Content
Option pg 151



Please refer to page 4 for icon definitions.



75 mm x 75 mm Adhesive Notepads

Paper colour

White



BIC® 75mm x 75mm Adhesive Notepads:

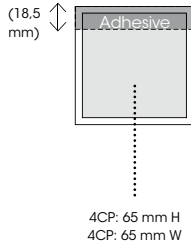

Standard paper

3507* 25 Sheets/ Pages / Hojas / Blatt / Fogli

3537* 50 Sheets/ Pages / Hojas / Blatt / Fogli

3567 100 Sheets/ Pages / Hojas / Blatt / Fogli

Recycled paper

3505* 25 Sheets/ Pages / Hojas / Blatt / Fogli

3535* 50 Sheets/ Pages / Hojas / Blatt / Fogli

3565 100 Sheets/ Pages / Hojas / Blatt / Fogli



• Popular size!

• Un format populaire

• ¡Tamaño popular!

• Die beliebteste Größe!

• La dimensione più richiesta!

Imprint
4CP

Impression
4CP

Impresión
4CP

Personalisierung
4CP

Stampa
4CP

25 sheets

50 sheets

100 sheets

Min Qty.: 500 units



= 6,2 Kg (approx.)



= 5,9 Kg (approx.)



= 6,1 Kg (approx.)



BIC ecolutions
Recycled Content
Option pg 151



pg 162

Please refer to page 4 for icon definitions.



101 mm x 75 mm Adhesive Notepads



Paper colour

White

BIC® 101mm x 75mm Adhesive Notepads:
(10,1 cm W x 7,5 cm H)

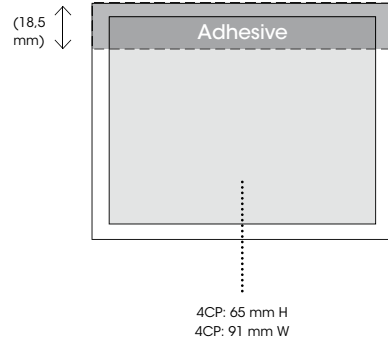

Standard paper

3512* 25 Sheets/ Pages / Hojas / Blatt / Fogli

3542* 50 Sheets/ Pages / Hojas / Blatt / Fogli

3572 100 Sheets/ Pages / Hojas / Blatt / Fogli

Recycled paper

3510* 25 Sheets/ Pages / Hojas / Blatt / Fogli

3540* 50 Sheets/ Pages / Hojas / Blatt / Fogli

3570 100 Sheets/ Pages / Hojas / Blatt / Fogli

- The bestseller!
- Vibrant 4-colour process imprint!

Imprint
4CP

- Le bestseller!
- Impression quadrichromie éclatante !

Impression
4CP

- ¡El bestseller!
- ¡Impresión vibrante a 4 colores!

Impresión
4CP

- Unser Bestseller!
- Kräftiger Vierfarbdruck!

Personalisierung
4CP

- Il più venduto!
- Stampa quadricromatica con colori brillanti!

Stampa
4CP



25 sheets

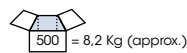

500 = 8,2 Kg (approx.)

50 sheets

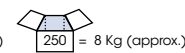

250 = 8 Kg (approx.)

100 sheets

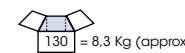

130 = 8,3 Kg (approx.)

Min Qty.: 500 units
Min Qty.: 250 units Medium 50 sheets



101 mm x 75 mm Alternating Sheet Imprint NEW!

Paper colour

White

BIC® 101 mm x 75 mm Adhesive Notepads:
(10,1 cm W x 7,5 cm H)

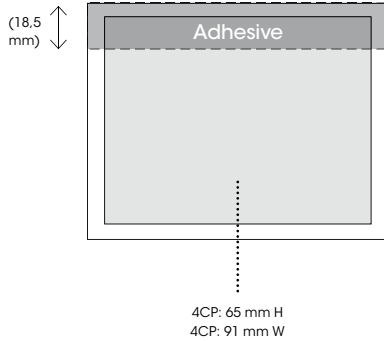

Standard paper

3514* 25 Sheets/ Pages / Hojas / Blatt / Fogli

3544* 50 Sheets/ Pages / Hojas / Blatt / Fogli

Recycled paper

3513* 25 Sheets/ Pages / Hojas / Blatt / Fogli

3543* 50 Sheets/ Pages / Hojas / Blatt / Fogli



- Alternating Sheet imprint!
- Up to 2 different messages on the same notepad!

- Alternating Sheet imprint!
- Jusqu'à 2 messages différents sur le même notepad!

- Alternating Sheet imprint!
- Hasta 2 mensajes diferentes en un mismo bloc!

- Alternating Sheet imprint!
- Bis zu verschiedene Motive auf dem gleichen Haftnotizblock!

- Alternating Sheet imprint!
- Possibilità di stampare 2 loghi diversi nello stesso blocchetto!

Imprint
4CP

Impression
4CP

Impresión
4CP

Personalisierung
4CP

Stampa
4CP

25 sheets

50 sheets

Min Qty.: 500 units
Min Qty.: 250 units Medium 50 sheets

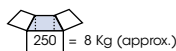
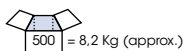

BIC ecolutions
Recycled Content
Option pg 151



pg 162

Please refer to page 4 for icon definitions.



Paper colour

White

BIC® 101 mm x 152 mm Adhesive Notepads:

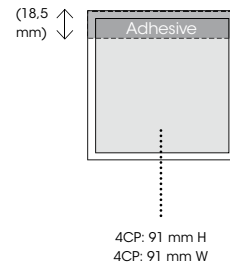

Standard paper

- 3518** 25 Sheets/ Pages / Hojas / Blatt / Fogli
- 3548** 50 Sheets/ Pages / Hojas / Blatt / Fogli
- 3578** 100 Sheets/ Pages / Hojas / Blatt / Fogli

Recycled paper

- 3516** 25 Sheets/ Pages / Hojas / Blatt / Fogli
- 3546** 50 Sheets/ Pages / Hojas / Blatt / Fogli
- 3576** 100 Sheets/ Pages / Hojas / Blatt / Fogli

- Vibrant 4-colour process imprint!
- Change the paper colour with a FREE flood coat!
- FREE phantom imprints create visual interest!
- Impression quadrichromie éclatante!
- Changez GRATUITEMENT la couleur du papier grâce à un aplat de couleurs !
- GRATUIT les techniques d'impression en shadow créent un visuel différent
- ¡Impresión vibrante a 4 colores!
- ¡Cambie el fondo de color del papel GRATIS!
- ¡Efectos de impresión al agua GRATUITOS que generan gran interés visual!
- Kräftiger Vierfarbdruck!
- Ändern Sie die Papierfarbe im Hintergrund mit einem KOSTENLOSEN Flood Aufdruck
- Ein KOSTENLOSER Phantomaufdruck erweckt visuelles Interesse!
- Stampa quadricromatica con colori brillanti!
- Cambia GRATUITAMENTE il colore della carta stampando uno sfondo
- Stampe ombreggiate GRATUITE che creano effetti visuali!

Imprint
4CP

Impression
4CP

Impresión
4CP

Personalisierung
4CP

Stampa
4CP



25 sheets

50 sheets

100 sheets

Min Qty.: 500 units

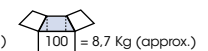
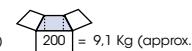
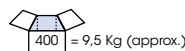



101 mm x 152 mm Adhesive Notepads

Paper colour

White

BIC® 101 mm x 152 mm Adhesive Notepads:

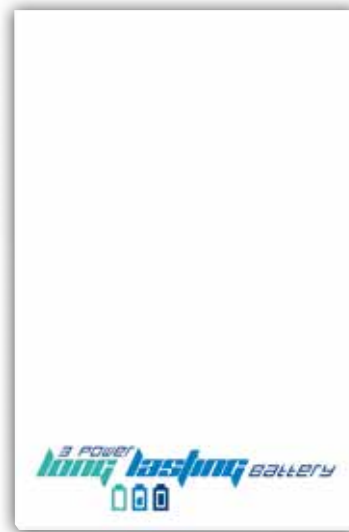
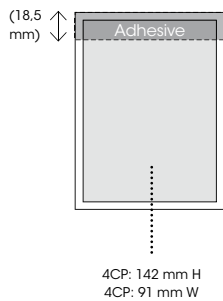

Standard paper

- 3517** 25 Sheets/ Pages / Hojas / Blatt / Fogli
- 3547** 50 Sheets/ Pages / Hojas / Blatt / Fogli
- 3577** 100 Sheets/ Pages / Hojas / Blatt / Fogli

Recycled paper

- 3515** 25 Sheets/ Pages / Hojas / Blatt / Fogli
- 3545** 50 Sheets/ Pages / Hojas / Blatt / Fogli
- 3575** 100 Sheets/ Pages / Hojas / Blatt / Fogli

• Lasting impression with flood coat or ruled lines!

• Impression durable sur marquage en fond perdu ou en ligne coupée par les marges

• ¡Impresión duradera con fondos coloridos o con líneas!!

• Langanhaltender Werbeeffect mit einem farbigen oder linierten Hintergrund

• Stampa a lunga durata su sfondo o su linee!

Imprint
4CP

Impression
4CP

Impresión
4CP

Personalisierung
4CP

Stampa
4CP

25 sheets

50 sheets

100 sheets

Min Qty.: 500 units

250 = 8,5 Kg (approx.)

125 = 8,2 Kg (approx.)

65 = 8,3 Kg (approx.)



BIC eolutions
Recycled Content
Option pg 151



pg 162

Please refer to page 4 for icon definitions.



75 mm x 75 mm Adhesive Die Cut Notepads



Paper colour

White

BIC® 75 mm x 75 mm Adhesive Die Cut Notepads:

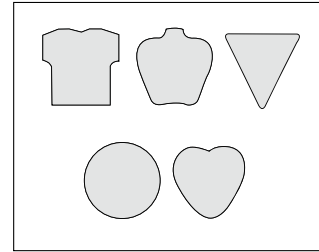

Standard paper

3603 25 Sheets/ Pages / Hojas / Blatt / Fogli

3607 50 Sheets/ Pages / Hojas / Blatt / Fogli

3611 100 Sheets/ Pages / Hojas / Blatt / Fogli

Recycled paper

3601 25 Sheets/ Pages / Hojas / Blatt / Fogli

3605 50 Sheets/ Pages / Hojas / Blatt / Fogli

3609 100 Sheets/ Pages / Hojas / Blatt / Fogli

- Choose from 5 stock shapes!
- Custom shapes available on request

- Choisissez parmi les 5 formes en stock!
- Formes spéciales sur demande

- ¡Esoja entre 5 formas diferentes!
- Formas personalizadas disponibles bajo petición

- Wählen Sie eine der 5 Standardformen
- Kundenspezifische Formen sind auf Anfrage erhältlich

- Scegli tra le oltre 5 forme disponibili!
- Forme personalizzate disponibili su richiesta

Imprint
4CP

Impression
4CP

Impresión
4CP

Personalisierung
4CP

Stampa
4CP



25 sheets

50 sheets

100 sheets

Min Qty.: 500 units

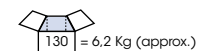
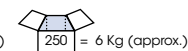
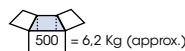



101 mm x 75 mm Adhesive Die Cut Notepads

Paper colour

White

BIC® 101 mm x 75 mm Adhesive Die Cut Notepads:

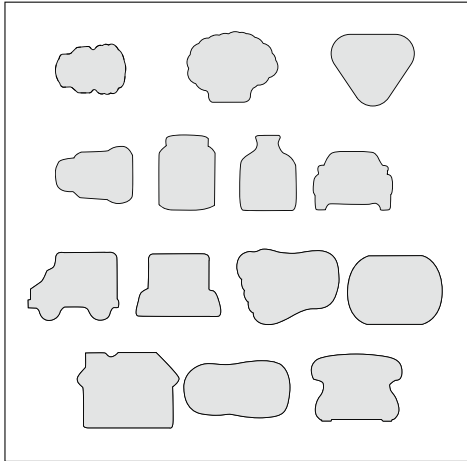

Standard paper

3604 25 Sheets/ Pages / Hojas / Blatt / Fogli

3608 50 Sheets/ Pages / Hojas / Blatt / Fogli

3612 100 Sheets/ Pages / Hojas / Blatt / Fogli

Recycled paper

3602 25 Sheets/ Pages / Hojas / Blatt / Fogli

3606 50 Sheets/ Pages / Hojas / Blatt / Fogli

3610 100 Sheets/ Pages / Hojas / Blatt / Fogli



- Choose from 14 stock shapes!
- Custom shapes available on request

- Choisissez parmi les 14 formes en stock!
- Formes spéciales sur demande

- ¡Escoja entre 14 formas diferentes!
- Formas personalizadas disponibles bajo petición

- Wählen Sie eine der 14 Standardformen
- Kundenspezifische Formen sind auf Anfrage erhältlich

- Scegli tra le oltre 14 forme disponibili!
- Forme personalizzate disponibili su richiesta

Imprint
4CP

Impression
4CP

Impresión
4CP

Personalisierung
4CP

Stampa
4CP

25 sheets

50 sheets

100 sheets

Min Qty.: 500 units

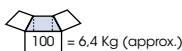
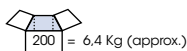
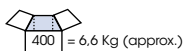

BIC ecolutions
Recycled Content
Option pg 151



pg 162

Please refer to page 4 for icon definitions.



101 mm x 152 mm Adhesive Beveled Notepads



Paper colour

White

BIC® 101 mm x 152 mm Adhesive Beveled Notepads:

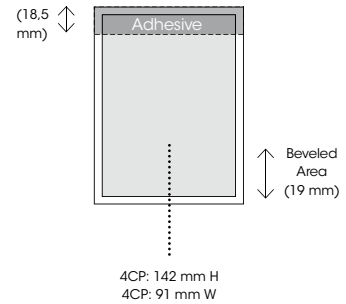

3742 150 Sheets/ Pages / Hojas / Blatt / Fogli

• Take advantage of a 3-dimensions message

• Tirez parti d'un message en 3 dimensions

• Aproveche el mensaje en 3 dimensiones

• Für Ihre dreidimensionale Werbebotschaft

• Il vantaggio del messaggio tridimensionale

Product Details
Beveled angle: 40°

Détail du produit
Angle biseauté: 40°

Detalles del producto
Acabado biselado: 40°

Produktdetail
Winkel des abgeschnittenen Bereiches: 40°

Dettaglio prodotto
Angolo smussato: 40°

Imprint
4CP

Impression
4CP

Impresión
4CP

Personalisierung
4CP

Stampa
4CP





Flag Booklet

Paper colour

White

BIC® Flag Booklet:
(11 cm W x 7,7 cm H)

Cover / Couverture / Portada / Cover / Copertina

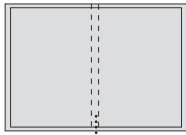

4CP: 67 mm H
4CP: 100 mm W

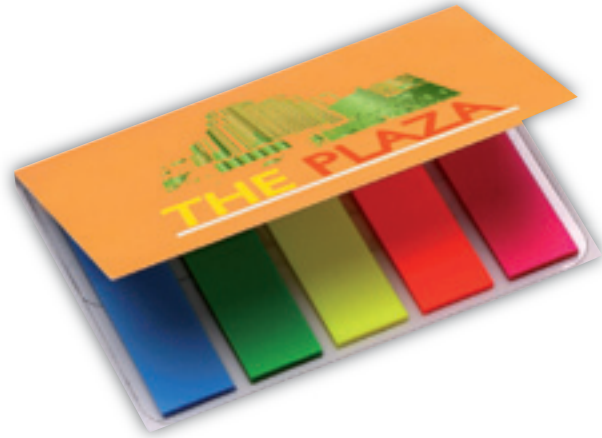

3730 Flag Booklet



• Artwork can be in a horizontal or vertical layout!

• Les illustrations peuvent être disposées horizontalement ou verticalement!

• ¡El diseño puede ser vertical u horizontal!

• Design in horizontaler oder vertikaler Ausrichtung möglich

• L'artwork può essere realizzato in orizzontale o verticale a seconda delle tue esigenze!

Product details
125 Mylar flags, 25 of each 5 colours

Détails du produit
125 index repositionnables, 25 de chaque couleur

Detalles del producto
125 Mylar flags, 25 de cada 5 colores

Produktdetails
125 Haftstreifen aus Polyesterfilm, 25 von jeder der 5 Farben

Dettaglio prodotti
125 segnapagina totali, 25 per colore

Imprint
4CP

Impression
4CP

Impresión
4CP

Personalisierung
4CP

Stampa
4CP

Min Qty.: 250 units  = 1,56 Kg (approx.)



pg 162

Please refer to page 4 for icon definitions.



75 mm x 75 mm Booklet



Paper colour

○ White

BIC® 75 mm x 75 mm Booklet:
Cover / Couverture / Portada / Cover / Copertina

3731: (15,6 cm W x 7,7 cm H)

3737: (15,9 cm W x 7,7 cm H)



4CP 67 mm H
4CP: 146 mm W



4CP 67 mm H
4CP: 149 mm W

BIC® 75mm x 75mm Adhesive Notepads:

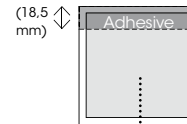

4CP: 65 mm H
4CP: 65 mm W

Standard paper

3731 25 Sheets/ Pages / Hojas / Blatt / Fogli

3737 50 Sheets/ Pages / Hojas / Blatt / Fogli



• Double impact of your message with a fully personalised cover

• Double impact de votre message avec une couverture entièrement personnalisée

• Doble impacto para su mensaje gracias a su cubierta personalizada

• Doppelte Werbewirkung mit vollpersonalisiertem Umschlag

• Doppio impatto per il tuo messaggio con la personalizzazione full color della copertina

Product details
1 BIC® 75mm x 75mm
Adhesive Notepads
25 or 50 sheets

Détails du produit
1 BIC® 75mm x 75mm
Adhesive Notepads
25 ou 50 pages

Detalles del producto
1 BIC® 75mm x 75mm
Adhesive Notepads
25 o 50 hojas

Produktdetails
1 BIC® 75mm x 75mm
Adhesive Notepads
25 oder 50 Blätter

Dettaglio prodotti
1 BIC® 75mm x 75mm
Adhesive Notepads
25 o 50 fogli

Imprint
4CP

Impression
4CP

Impresión
4CP

Personalisierung
4CP

Stampa
4CP

STICKY NOTE



pg 162



Please refer to page 4 for icon definitions.

25 sheets

50 sheets

Min Qty.: 500 units

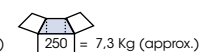
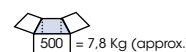



101 mm x 75mm Booklet NEW!

Paper colour

White

BIC® 101mm x 75mm Adhesive Booklet:
Cover / Couverture / Portada / Cover / Copertina

3738: (15,6 cm W x 10,3 cm H)

3739: (15,9 cm W x 10,3 cm H)

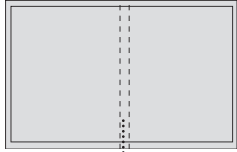

4CP: 93 mm H
4CP: 146 mm W

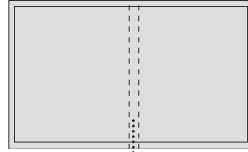

4CP: 93 mm H
4CP: 149 mm W

BIC® 101mm x 75mm Adhesive Notepads:

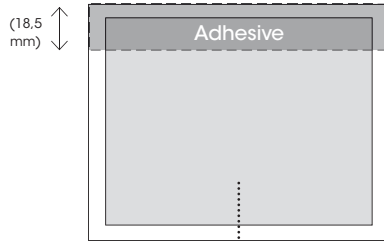

4CP: 65 mm H
4CP: 91 mm W



Standard paper

3738 25 Sheets / Pages / Hojas / Blatt / Fogli

3739 50 Sheets / Pages / Hojas / Blatt / Fogli



- FREE 4-color process on booklet cover!
- GRATUIT Impression quadri sur la couverture
- ¡Impresión a 4 colores GRATIS en la cubierta del booklet!
- KOSTENLOSER Vierfarbdruck auf dem Cover!
- Processo di stampa a quattro colori GRATUITO sulla copertina!

Product details

1 BIC® 101mm x 75mm Adhesive Notepads
25 or 50 sheets

Détails du produit

1 BIC® 101mm x 75mm Adhesive Notepads
25 ou 50 pages

Detalles del producto

1 BIC® 101mm x 75mm Adhesive Notepads
25 o 50 hojas

Produktdetails

1 BIC® 101mm x 75mm Adhesive Notepads
25 oder 50 Blätter

Dettaglio prodotti

1 BIC® 101mm x 75mm Adhesive Notepads
25 o 50 fogli

Imprint

4CP

Impression

4CP

Impresión

4CP

Personalisierung

4CP

Stampa

4CP

25 sheets

50 sheets

Min Qty.: 500 units

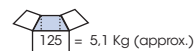
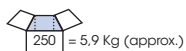

pg 162

Please refer to page 4 for icon definitions.



75 mm x 75 mm Adhesive Notepad with Flag Booklet



Paper colour

White

BIC® 75 mm x 75 mm Adhesive Notepad Flag Booklet: (15,8 cm W x 12,9 cm H)

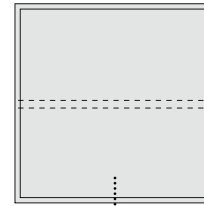

4CP: 119 mm H
4CP: 148 mm W

BIC® 101 mm x 75 mm Adhesive Notepads:

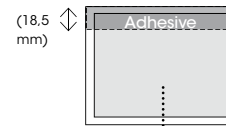

4CP: 65 mm H
4CP: 91 mm W

3732 75mm x 75mm Adhesive Notepad with Flag Booklet

• The multi-purpose notes tool

• Le "tout en un" pour la prise de notes

• ¡El bloc de notas multiuso!

• Das Multifunktionstool für Ihre Notizen

• Il blocchetto multi funzione!

Product details

1 BIC® 75mm x 75mm Adhesive Notepads (25 sheets)
125 Mylar flags, 25 of each 5 colours

Détail du produit

1 BIC® 75mm x 75mm Adhesive Notepads (25 pages)
125 Index repositionnables, 25 de chaque couleur

Detalles del producto

1 BIC® 75mm x 75mm Adhesive Notepads (25 hojas)
125 marcadores, 25 de cada uno de los 5 colores

Produktdetail

1 BIC® 75mm x 75mm Adhesive Notepads (25 Blätter)
125 Haftstreifen aus Polyesterfilm, 25 von jeder der 5 Farben

Dettaglio prodotti

1 BIC® 75mm x 75mm Adhesive Notepads (25 fogli)
125 segnapagina totali, 25 per colore

Imprint
4CP

Impression
4CP

Impresión
4CP

Personalisierung
4CP

Stampa
4CP





101 mm x 75 mm Mini Pencil Booklet

Paper colour

White

BIC® 101 mm x 75 mm Mini Pencil Booklet:
(18 cm W x 11,2 cm H)

Cover / Couverture / Portada / Cover / Copertina

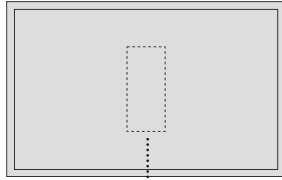

4CP: 102 mm H
4CP: 170 mm W

BIC® 101 mm x 75mm Adhesive Notepads:

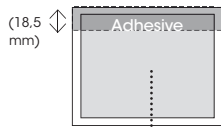

4CP: 65 mm H
4CP: 91 mm W

BIC® Matic Mini

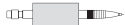

SP: 40 mm W x 20mm H



Barrel and Trims
Transparent

(51)



3734 101mm x 75mm Mini Pencil Booklet

• Twice the impact,
twice as useful

• Deux fois plus d'impact,
deux fois plus utile

• Doble impacto,
doble utilidad

• Doppelte Werbewirkung,
doppelter Nutzen

• Raddoppia l'impatto,
raddoppia l'utilizzo!

Product details

1 BIC® 101mm x 75mm
Adhesive Notepads
(50 sheets)
1 BIC® Matic Mini

Détail du produit

1 BIC® 101mm x 75mm
Adhesive Notepads
(50 pages)
1 BIC® Matic Mini

Detalles del producto

1 BIC® 101mm x 75mm
Adhesive Notepads
(50 hojas)
1 BIC® Matic Mini

Produktdetail

1 BIC® 101mm x 75mm
Adhesive Notepads
(50 Blätter)
1 BIC® Matic Mini

Dettaglio prodotti

1 BIC® 101mm x 75mm
Adhesive Notepads
(50 fogli)
1 BIC® Matic Mini

Imprint

Cover: 4CP
BIC® Adhesive
Notepads: 4CP
BIC® Matic Mini:
SP 1 colour

Impression

Cover: 4CP
BIC® Adhesive
Notepads: 4CP
BIC® Matic Mini:
SP 1 couleur

Impresión

Cover: 4CP
BIC® Adhesive
Notepads: 4CP
BIC® Matic Mini:
SP 1 color

Personalisierung

Cover: 4CP
BIC® Adhesive
Notepads: 4CP
BIC® Matic Mini:
SP 1 Farbe

Stampa

Cover: 4CP
BIC® Adhesive
Notepads: 4CP
BIC® Matic Mini:
SP 1 colore

Min Qty.: 250 units with unimprinted pad
Min Qty.: 500 units with imprinted pad

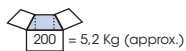

pg 162

Please refer to page 4 for icon definitions.

www.bicgraphic.com 105



Mini Clic Stic Organizer



pg.27



Paper colour

○ White

BIC® Mini Clic Stic Organizer:
(18 cm W x 13 cm H)

Cover / Couverture / Portada / Cover / Copertina

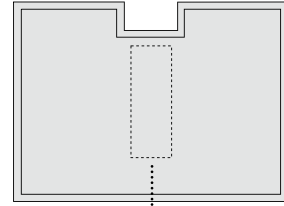

4CP: 120 mm H
4CP: 170 mm W

BIC® 75 mm x 182 mm
Non-Adhesive
Scratch Pad:

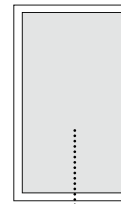

4CP: 117 mm H
4CP: 65 mm W

BIC® 75 mm x 75 mm
Adhesive Notepads:

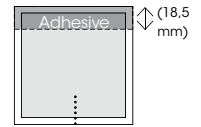

4CP: 65 mm H
4CP: 65 mm W

BIC® Clic Stic™ Mini:



(SP: 45 mm W x 10 mm H)



(SP: 25 mm W x 20 mm H)

3733 Mini Clic Stic Organizer

• Artwork can be in a horizontal or vertical layout!

• Les illustrations peuvent être disposées à l'horizontale ou à la verticale!

• ¡El diseño puede ser vertical u horizontal!

• Design in horizontaler oder vertikaler Ausrichtung möglich

• L'artwork può essere realizzato in orizzontale o verticale a seconda delle tue esigenze!

Product details

- BIC® 75 x 75mm Ad. Notepads (25)
- BIC® 75x128mm Scratch Pad (40)
- 125 Mylar flags, 25 of each 5 colours
- BIC® Clic Stic™ Mini

Détail du produit

- BIC® 75 x 75mm Ad. Notepads (25)
- BIC® 75 x 128mm Scratch Pad (40)
- 125 Index repositionnables, 25 de chaque couleur
- BIC® Clic Stic™ Mini

Detalles del producto

- BIC® 75 x 75mm Ad. Notepads (25)
- BIC® 75 x 128mm Scratch Pad (40)
- 125 marcadores, 25 de cada uno de los 5 colores
- BIC® Clic Stic™ Mini

Produktdetail

- BIC® 75 x 75mm Ad. Notepads (25)
- BIC® 75 x 128mm Scratch Pad (40)
- 125 Haftstreifen aus Polyesterfilm, 25 von jeder der 5 Farben
- BIC® Clic Stic™ Mini

Dettaglio prodotti

- BIC® 75 x 75mm Ad. Notepads (25)
- BIC® 75 x 128mm Scratch Pad (40)
- 125 segnapagina totali, 25 per colore
- BIC® Clic Stic™ Mini

Imprint

Cover: 4CP
BIC® 75x75mm: 4CP
BIC® 75x182mm: 4CP
BIC® Clic Stic TM Mini:
SP 1 colour

Impression

Cover: 4CP
BIC® 75x75mm: 4CP
BIC® 75x182mm: 4CP
BIC® Clic Stic TM Mini:
SP 1 couleur

Impresión

Cover: 4CP
BIC® 75x75mm: 4CP
BIC® 75x182mm: 4CP
BIC® Clic Stic TM Mini:
SP 1 color

Personalisierung

Cover: 4CP
BIC® 75x75mm: 4CP
BIC® 75x182mm: 4CP
BIC® Clic Stic TM Mini:
SP 1 Farbe

Stampa

Cover: 4CP
BIC® 75x75mm: 4CP
BIC® 75x182mm: 4CP
BIC® Clic Stic TM Mini:
SP 1 colore



pg 162



Please refer to page 4 for icon definitions.

Min Qty.: 500 units 125 = 7 Kg (approx.)

* Barrel of the product must be white / Le corps du produit doit être blanc opaque/ El cuerpo del producto debe ser blanco / Der Schaft des Produkts muss weiss sein / Il colore del corpo deve essere bianco



Mini Digital Clic Stic Organizer

Paper colour

○ White

BIC® Mini Digital Clic Stic Organizer:
(18 cm W x 13 cm H)

Cover / Couverture / Portada / Cover / Copertina

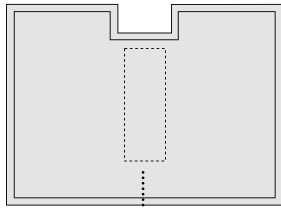

4CP: 120 mm H
4CP: 170 mm W

BIC® 75 mm x 182 mm
Non-Adhesive
Scratch Pad:

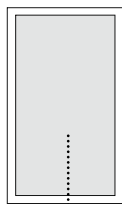

4CP: 117 mm H
4CP: 65 mm W

BIC® 75 mm x 75 mm
Adhesive Notepads:

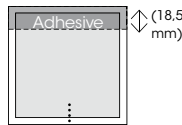

4CP: 65 mm H
4CP: 65 mm W

BIC® Clic Stic™ Mini Digital:



DG: image area:
86 mm W x 26,4 mm H
DG: text area:
78 mm W x 24 mm H

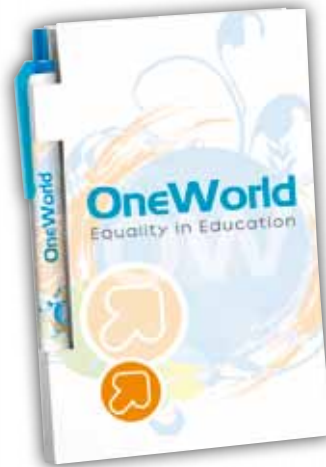

pg.27



3735 Mini Digital Clic Stic Organizer

• The perfect communication set!

• Le kit de communication idéal!

• ¡El set perfecto de comunicación!

• Das perfekte Kommunikationsset - das Büro für unterwegs!

• Il set per la perfetta comunicazione!

Product details

- BIC® 75 x 75mm Ad. Notepads (25)
- BIC® 75x 128mm Scratch Pad (40)
- 125 Mylar flags, 25 of each 5 colours
- BIC® Clic Stic™ Mini Digital

Détail du produit

- BIC® 75 x 75mm Ad. Notepads (25)
- BIC® 75 x 128mm Scratch Pad (40)
- 125 Index, 25 de chaque couleur
- BIC® Clic Stic™ Mini Digital

Detalles del producto

- BIC® 75 x 75mm Ad. Notepads (25)
- BIC® 75 x 128mm Scratch Pad (40)
- 125 marcadores, 25 de cada color
- BIC® Clic Stic™ Mini Digital

Produktdetail

- BIC® 75 x 75mm Ad. Notepads (25)
- BIC® 75 x 128mm Scratch Pad (40)
- 125 Haftstreifen aus Polyesterfilm, 25 von jeder der 5 Farben
- BIC® Clic Stic™ Mini Digital

Dettaglio prodotti

- BIC® 75 x 75mm Ad. Notepads (25)
- BIC® 75 x 128mm Scratch Pad (40)
- 125 segnapagina totali, 25 per colore
- BIC® Clic Stic™ Mini Digital

Imprint

Cover: 4CP
BIC® 75x75mm: 4CP
BIC® 75x182mm: 4CP
BIC® Clic Stic™ Mini Digital: DG barrel

Impression

Cover: 4CP
BIC® 75x75mm: 4CP
BIC® 75x182mm: 4CP
BIC® Clic Stic™ Mini Digital: DG corps

Impresión

Cover: 4CP
BIC® 75x75mm: 4CP
BIC® 75x182mm: 4CP
BIC® Clic Stic™ Mini Digital: DG: cuerpo

Personalisierung

Cover: 4CP
BIC® 75x75mm: 4CP
BIC® 75x182mm: 4CP
BIC® Clic Stic™ Mini Digital: DG Schaff

Stampa

Cover: 4CP
BIC® 75x75mm: 4CP
BIC® 75x182mm: 4CP
BIC® Clic Stic™ Mini Digital: DG corpo

Min Qty: 500 units = 7 Kg (approx.)

* Barrel of the product must be white / Le corps du produit doit être blanc opaque / El cuerpo del producto debe ser blanco / Der Schaff des Produkts muss weiss sein / Il colore del corpo deve essere bianco



pg 162

Please refer to page 4 for icon definitions.



75 mm x 128 mm Non-Adhesive Scratch Pad



Paper colour

White

BIC® 75 mm x 128 mm Non-Adhesive Scratch Pad:



4CP: 117 mm H
4CP: 65 mm W

3760 20 Sheets / Pages / Hojas / Blatt / Fogli

3761 40 Sheets / Pages / Hojas / Blatt / Fogli

• Vibrant 4-Colour Process Imprint FREE!

• Impression quadrichromie élatante GRATUITE!

• Impresión en cuatricromía GRATIS!

• 4-Farb-Offset-Druck inklusive!

• Vivace personalizzazione a 4 colori gratuita!

Imprint
4CP

Impression
4CP

Impresión
4CP

Personalisierung
4CP

Stampa
4CP



20 sheets

40 sheets

Min Qty.: 500 units



400 = 5,4 / 8,6 Kg (approx.)



200 = 5,2 / 8 Kg (approx.)



96 mm x 152 mm Non-Adhesive Scratch Pad

Paper colour

White

BIC® 96 mm x 152 mm Non-Adhesive Scratch Pad:

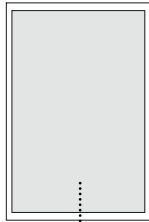

4CP: 142 mm H
4CP: 91 mm W



3762 20 Sheets / Pages / Hojas / Blatt / Fogli

3763 40 Sheets / Pages / Hojas / Blatt / Fogli

• Perfect pad for lists and notes!

• Un bloc parfait pour les listes et les notes!

• ¡El bloc perfecto para listas y notas!

• Der perfekte Block für Ihre Notizen!

• Il blocchetto ideal per liste e appunti!

Imprint
4CP

Impression
4CP

Impresión
4CP

Personalisierung
4CP

Stampa
4CP

20 sheets

40 sheets

Min Qty: 500 units



= 5,4 / 8,6 Kg (approx.)



= 5,2 / 8 Kg (approx.)



pg 162

Please refer to page 4 for icon definitions.

Notebooks Notebooks Notebooks Notebooks Notebooks

BIC® Notebooks Plastic Cover112

BIC® Notebooks Chipboard Cover114

BIC® Notebooks Plastic Cover
Fashion Colours113

BIC® Notebooks Chipboard
Cover 4 - Colours115

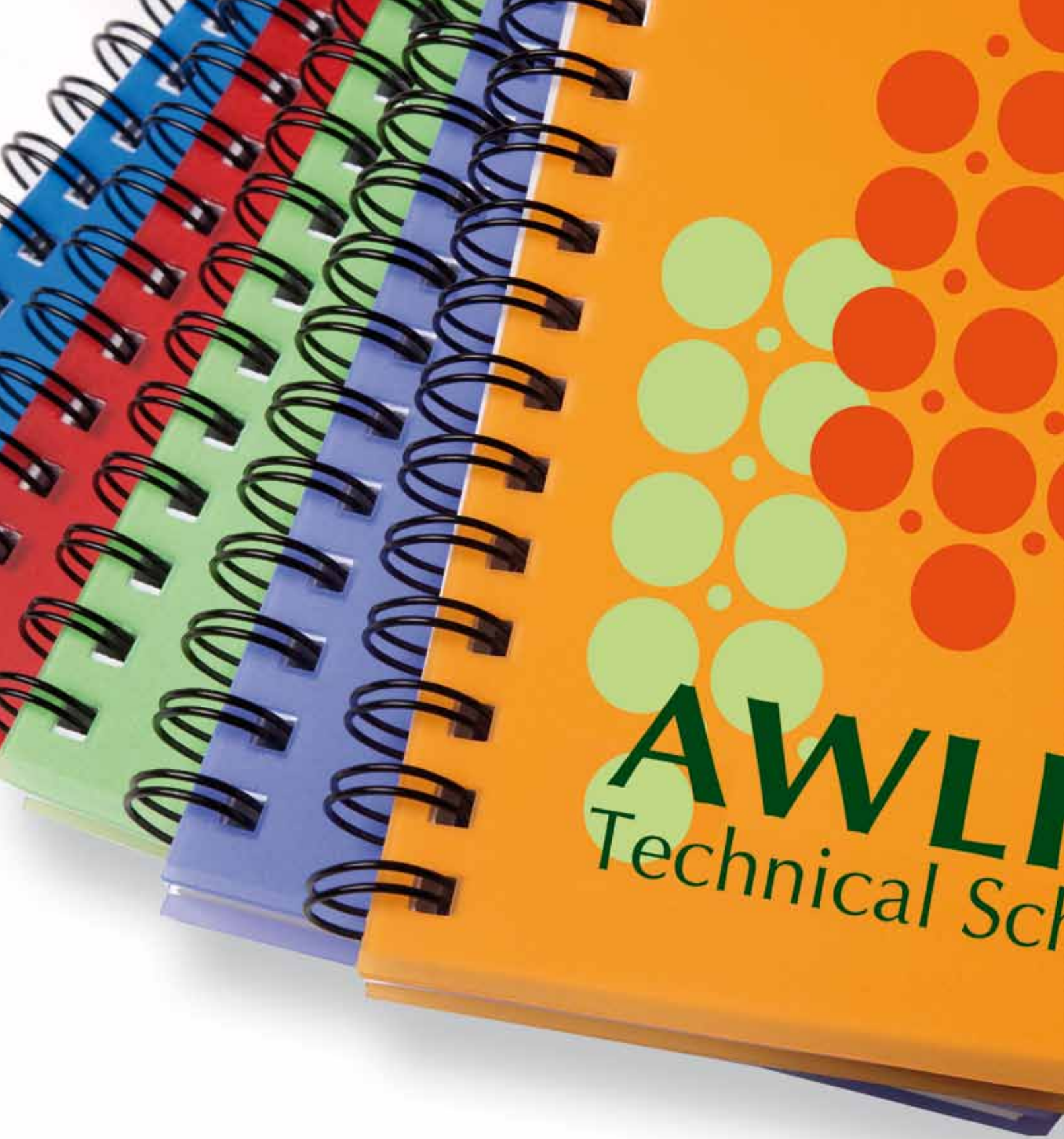

AWLI
Technical Sch



Notebooks



51

BIC® Notebooks Plastic Cover Small:
(12,5 cm W x 17,5 cm H)

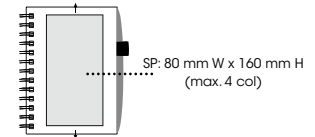

BIC® Notebooks Plastic Cover Large:
(17,5 cm W x 25 cm H)

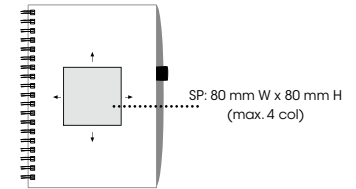

3700 Small/ Petit /Pequeño / Klein/ Piccolo

3701 Large/ Grand /Grande / Groß/ Grande

• Sturdy elastic loop

• Boucle élastique résistante

• Soporte elástico resistente

• Robuste, elastische Stiftschleife

• Laccio elastico resistente

Standard Paper

All notebooks come with 100 sheet of lined 80g paper.

Papier standard

Chaque notebook comprend 100 feuilles de papier ligné de 80 g.

Papel estándar

Todos los cuadernos tienen 100 páginas de papel pautado de 80 gr.

Standardpapier

Alle Notizbücher mit liniertem Papier 80g, 100 Blatt.

Carta standard

Tutti i notebook sono costituiti da 100 fogli a righe. Carta da 80 gr.

Imprint

SP: up to 4 colours

Impression

SP: jusqu'à 4 couleurs

Impresión

SP: hasta 4 colores

Personalisierung

SP: max. 4 Farben

Stampa

SP: max. 4 colori



Notebooks Plastic Cover Fashion Colours



39



66



71



67



68

BIC® Notebooks Plastic Cover Fashion Colours
(12,5 cm W x 17,5 cm H)

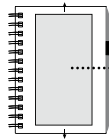

SP: 80 mm W x 160 mm H
(max. 4 col)

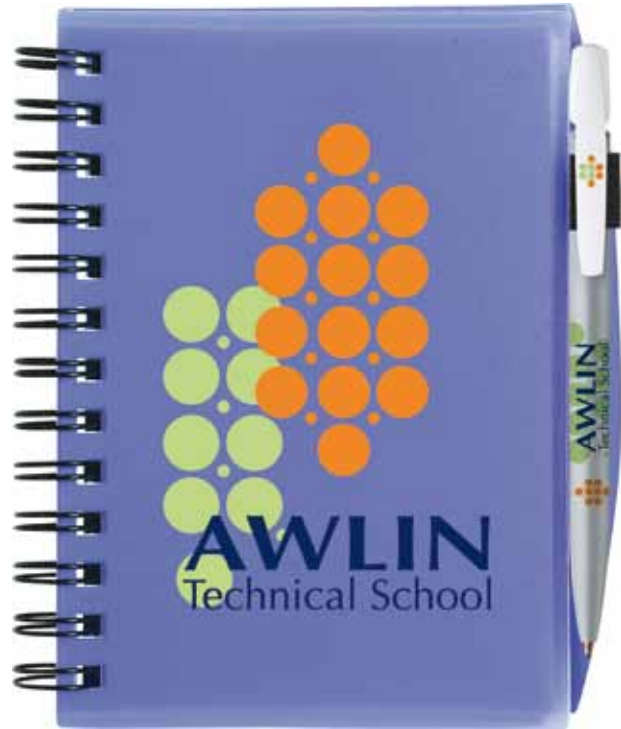

3706 Small/ Petit /Pequeño / Klein/ Piccolo

• Trendy
bright colours

• Des couleurs
vives et tendances

• Modernos
colores brillantes

• Modisch
kräftige Farben

• Colori brillanti
e moderni

Standard Paper
All notebooks come
with 100 sheet of lined
80g paper.

Papier standard
Chaque notebook
comprend 100 feuilles de
papier ligné de 80 g.

Papel estándar
Todos los cuadernos
tienen 100 páginas de
papel pautado de 80 gr.

Standardpapier
Alle Notizbücher
mit liniertem
Papier 80g, 100 Blatt.

Carta standard
Tutti i notebooks sono
costituiti da 100 fogli a
righe. Carta da 80 gr.

Imprint
SP: up to 4 colours

Impression
SP: jusqu'à 4 couleurs

Impresión
SP: hasta 4 colores

Personalisierung
SP: max. 4 Farben

Stampa
SP: max. 4 colori

Min Qty: 50 units  = 6,5 Kg (approx.)



pg 162

Please refer to page 4 for icon definitions.

www.bicgraphic.com 113

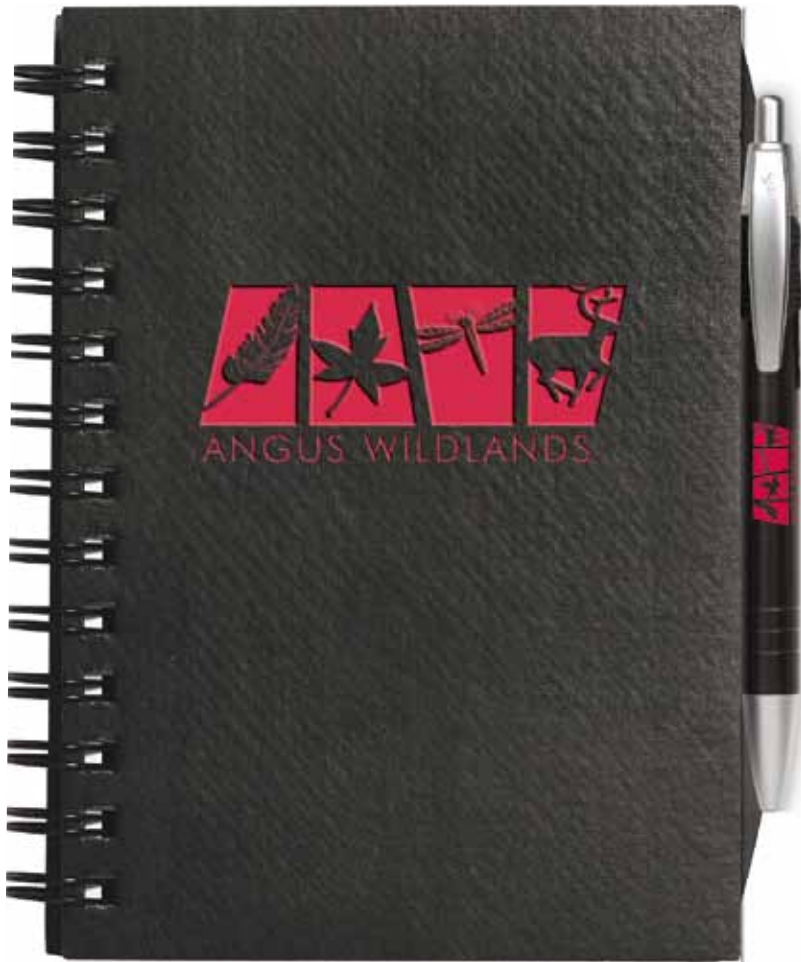

2

BIC® Notebooks Chipboard Cover:
(12,5 cm W x 17,5 cm H)

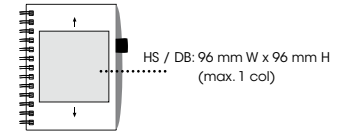

BIC® Notebooks Chipboard Cover:
(17,5 cm W x 25 cm H)

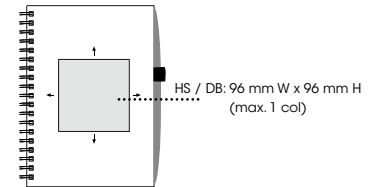

3702 Small / Petit / Pequeño / Klein / Piccolo
3703 Large / Grand / Grande / Groß / Grande

• Perfect combination with BIC® Writing Instrument

• Se combine parfaitement avec l'instrument d'écriture BIC®

• Perfecta combinación con BIC® Writing Instrument

• Die perfekte Ergänzung zu Ihrem BIC® Schreibgerät

• Perfetta combinazione con i Bic® Writing Instrument

Standard Paper
All notebooks come with 100 sheet of lined 80g paper.

Papier standard
Chaque notebook comprend 100 feuilles de papier ligné de 80 g.

Papel estándar
Todos los cuadernos tienen 100 páginas de papel pautado de 80 gr.

Standardpapier
Alle Notizbücher mit liniertem Papier 80g, 100 Blatt.

Carta standard
Tutti i notebooks sono costituiti da 100 fogli a righe. Carta da 80 gr.

Imprint
HS: 1 colour
DB: 1 colour

Impression
HS: 1 couleur
DB: 1 couleur

Impresión
HS: 1 color
DB: 1 color

Personalisierung
HS: 1 Farbe
DB: 1 Farbe

Stampa
HS: 1 colore
DB: 1 colore



Notebooks Chipboard Cover 4-Colours



01

BIC® Notebooks Chipboard Cover 4-Colours:
(12,5 cm W x 17,5 cm H)

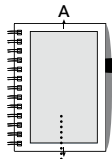

4CP: 89 mm W x 152 mm H

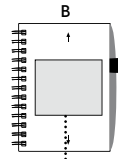

4CP: 89 mm W x 76 mm H

BIC® Notebooks Chipboard Cover 4-Colours:
(17,5 cm W x 25 cm H)

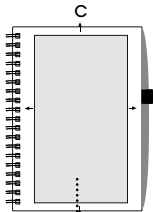

4CP: 127 mm W x 229 mm H

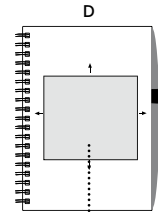

4CP: 127 mm W x 114 mm H

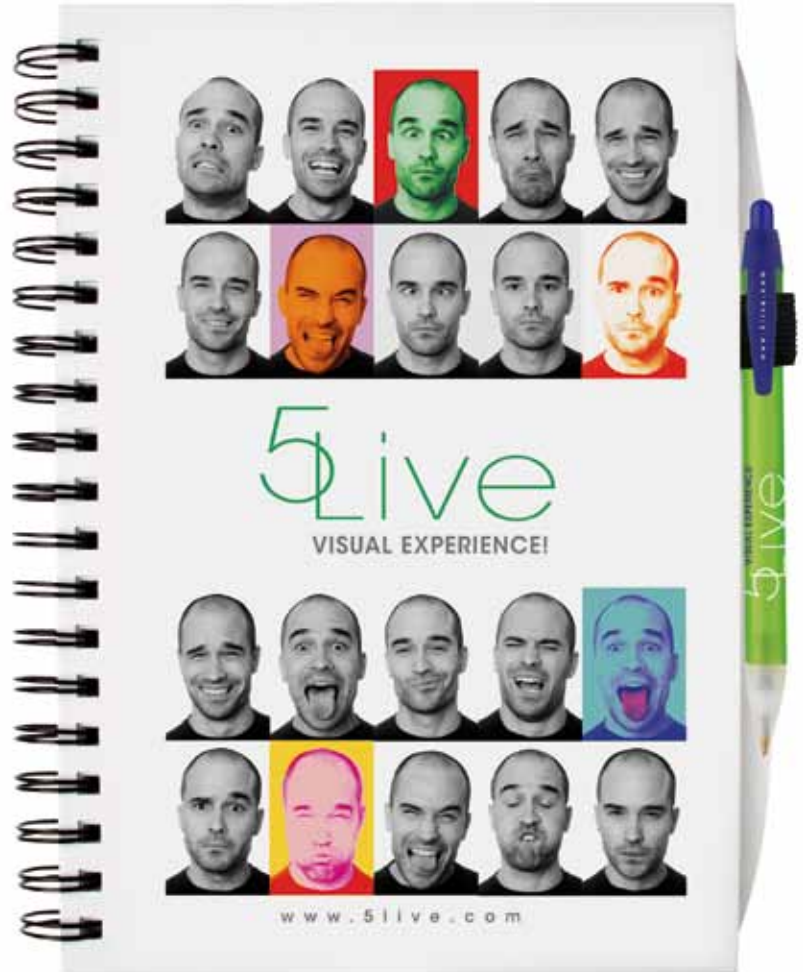

3708 / 3709 Small/ Petit /Pequeño / Klein/ Piccolo
3710 / 3711 Large/ Grand /Grande / Groß/ Grande



• FREEDOM, 4-colour process imprint!

• LIBERTÉ, impression en quadrichromie !

• LIBERTAD, jimpresión en cuatricromía!

• INKLUSIVE, 4-Farb-Offsetdruck!

• LIBERTÀ, stampa in quadricomia!

Standard Paper
All notebooks come with 100 sheet of lined 80g paper.

Papier standard
Chaque notebook comprend 100 feuilles de papier ligné de 80 g.

Papel estándar
Todos los cuadernos tienen 100 páginas de papel pautado de 80 gr.

Standardpapier
Alle Notizbücher mit liniertem Papier 80g, 100 Blatt.

Carta standard
Tutii i notebooks sono costituiti da 100 fogli a righe. Carta da 80 gr.

Imprint
4CP

Impression
4CP

Impresión
4CP

Personalisierung
4CP

Stampa
4CP

Small

Large

Min Qty.: 50 units

25 = 6,8 Kg (approx.)

15 = 8 Kg (approx.)



pg 162

Please refer to page 4 for icon definitions.

Lighters & Cases Lighters & Cases Lighters & Cases Lighters

BIC® J25	118
BIC® J23	119
BIC® J26	120
BIC® J39	121
BIC® J38	122
BIC® Mega Lighter 	123

BIC® Gripper	124
BIC® Styl'it Fashion & Squeeze	125
BIC® C2 Metal	126
BIC® Styl'it Luxury	127
BIC® Lighters Security	128
BIC® Lighters Security	129



Lighters & Cases





Standard Colours:



All Black Colours:



Silver Colours:



Pastel Colours:



BIC® J25:
(2,2 cm W x 6,2 cm H x 1,1 cm D)

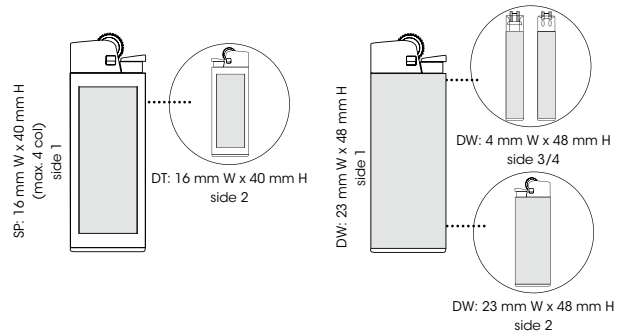

2360* Standard
2364* Silver
2377* Pastel

2362* All Black
2368 Digital Wrap
2369 Dig. Transfer

• Convenient portable size

• Format de poche

• Tamaño conveniente

• Praktisch handliches Design

• Dimensione conveniente

Imprint

SP: body up to 4 colours
DW
DT

Impression

SP: corps jusqu'à 4 couleurs
DW
DT

Impresión

SP: cuerpo hasta 4 colores
DW
DT

Personalisierung

SP: Körper bis zu 4 Farben
DW
DT

Stampa

SP: corpo max. 4 colori
DW
DT

Colours



BIC® J23:
(2,2 cm W x 7,6 cm H x 1,1 cm D)

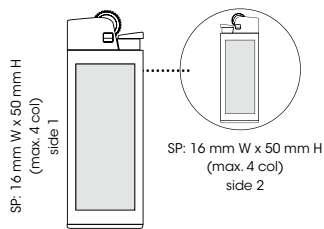

2340 Lighter



- Thin and elegant
- Fin et élégant
- Fino y elegante
- Schlank und elegant
- Sottile ed elegante

Imprint

SP: body up to 4 colours

Impression

SP: corps jusqu'à 4 couleurs

Impresión

SP: cuerpo hasta 4 colores

Personalisierung

SP: Körper bis zu 4 Farben

Stampa

SP: corpo max. 4 colori

Min Qty.: 300 units



300 = 4,7 Kg (approx.)



600 = 9,3 Kg (approx.)

Standard packaging: in tray of 50 u. / barquette 50 u. / en bandeja de 50 u. / 50er Aufsteller / In vassoio da 50 pezzi



pg 162

Please refer to page 4 for icon definitions.



Colours:



BIC® J26:
(2,5 cm W x 8,2 cm H x 1,5 cm D)

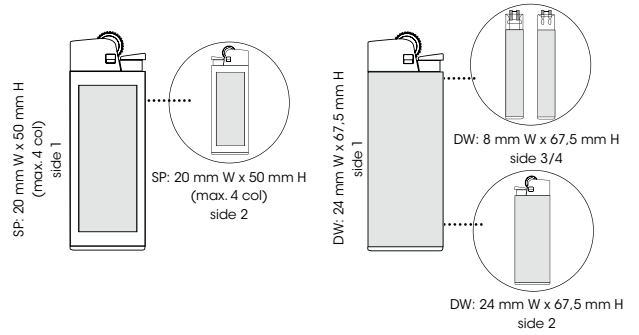

2320* Standard
2328 Digital wrap

- 3000 lights!
- Comfortable to use

Imprint
SP: body up to 4 colours
DW

- 3000 allumages!
- Pratique à utiliser

Impression
SP: corps jusqu'à 4 couleurs
DW

- ¡3000 encendidas!
- Uso confortable

Impresión
SP: cuerpo hasta 4 colores
DW

- 3.000 Zündungen!
- Einfache Handhabung

Personalisierung
SP: Körper bis zu 4 Farben
DW

- 3000 accensioni!
- Uso confortevole

Stampa
SP: corpo max. 4 colori
DW

Chrome Hood
Colours:



Silver
Colours:



BIC® J39:
(2,5 cm W x 6,3 cm H x 1,3 cm D)

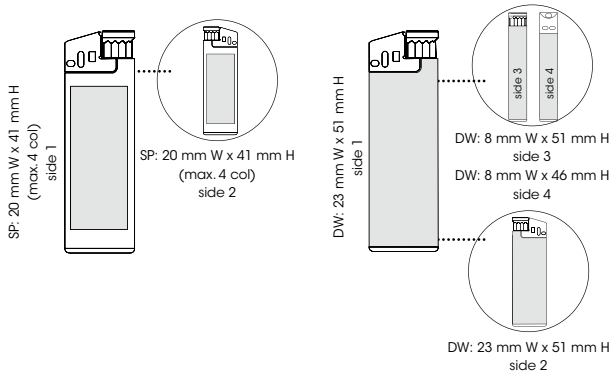

- 2479* Chrome Hood
- 2478* Silver
- 2481 Digital wrap



• Convenient mini size	• Taille mini et pratique	• Tamaño pequeño conveniente	• Praktisches Miniformat	• Conveniente dimensione mini
Imprint SP: body up to 4 colours DW	Impression SP: corps jusqu'à 4 couleurs DW	Impresión SP: cuerpo hasta 4 colores DW	Personalisierung SP: Körper bis zu 4 Farben DW	Stampa SP: corpo max. 4 colori DW

Min Qty: 300 units = 6 Kg (approx.) = 11,1 Kg (approx.)

Standard packaging: in tray of 50 u. / barquette 50 u. / en bandeja de 50 u. / 50er Aufsteller / In vassoio da 50 pezzi





Chrome Hood
Colours:



Gold
Colours:



BIC® J38:
(2,5 cm W x 7,9 cm H x 1,3 cm D)

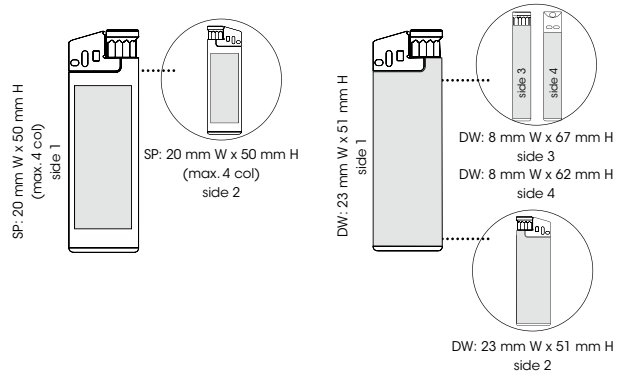

- 2452*** Chrome Hood
- 2451*** Gold Hood
- 2458** Digital Wrap

- Reliable ignition
- Long lasting

- Allumage fiable
- Longue durée de vie

- Encendido fiable
- Duradero

- Zuverlässige Zündung
- Lange Lebensdauer

- Accensione sicura
- Di lunga durata

Imprint
SP: body up to 4 colours
DW

Impression
SP: corps jusqu'à 4 couleurs
DW

Impresión
SP: cuerpo hasta 4 colores
DW

Personalisierung
SP: Körper bis zu 4 Farben
DW

Stampa
SP: corpo max. 4 colori
DW





Mega Lighter NEW!

Colours:



BIC® Mega Lighter:
(4,3 cm W x 3,6 cm H x 19,4 cm D)

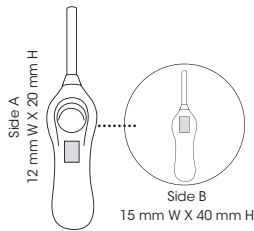

2500 Mega Lighter

- Curvier body shape for comfortable handling
- Compact and trendy
- A retractable hook for easy storage
- Visible gas supply: easy to check gas level

- Forme plus incurvée du corps pour une manipulation agréable
- Compact et branché
- Crochet rétractable pour un rangement facile
- Alimentation visible du gaz : facile pour contrôler le niveau de gaz

- Forma del cuerpo curvada para un cómodo manejo
- Compacto y moderno
- Gancho plegable para colgarlo con facilidad
- Suministro de gas visible: es fácil comprobar el nivel de gas

- Gekrümmter Schaft für angenehme Handhabung
- Kompakt und modisch
- Einschiebbarer Aufhänger für eine einfache Aufbewahrung
- Gastank sichtbar: Aktuelle Füllmenge ist einfach abzulesen

- Sagoma del corpo più ricurva per una comoda maneggevolezza
- Compatto e trendy
- Gancio retraibile per riporlo facilmente
- Riserva visibile di gas: per controllare facilmente il livello di gas

Imprint

PD: body up to 2 colours

Impression

PD : corps jusqu'à 2 couleurs

Impresión

PD: cuerpo hasta 2 colores

Personalisierung

PD: Schaft bis zu 2 Farben

Stampa

PD: corpo fino a 2 colori

Min Qty.: 100 units = 7,03 Kg (approx.)

Standard packaging: 100 pcs in an export carton in grid

pg 162

Please refer to page 4 for icon definitions.

www.bicgraphic.com **123**



Colours:



BIC® Gripper:
(3,0 cm W x 7,3 cm H x 1,8 cm D)

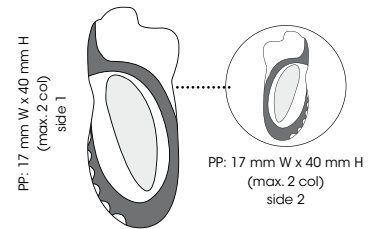

2394 Case

- Maximum comfort for easy handling
- Bi-material model

- Confort maximum pour une manipulation facile
- Modèle bi-matière

- Máximo confort para un manejo sencillo
- Modelo bimaterial

- Maximaler Komfort, einfache Handhabung

- Massimo conforto per un facile utilizzo
- Modello BI-materiale

Imprint
PD: body up to 2 colours

All cases are delivered with a transparent white lighter

Impression
PD: corps jusqu'à 2 couleurs

Toutes nos coques sont livrées avec un briquet mini blanc translucide

Impresión
PD: cuerpo hasta 2 colores

Todas las fundas incluyen un encendedor blanco transparente

Personalisierung
PD: Schaff max. 2 Farben

Alle Hüllen werden mit einem transparent weissen J25mini Feuerzeug geliefert

Stampa
PD: corpo max. 2 colori

Tutti i copri accendini sono forniti con l'accendino bianco frosted



Styl'it Fashion & Squeeze

BIC® Styl'it Fashion Colours



51

66

67

BIC® Squeeze Colours



04

10

13

BIC® Styl'it Fashion:
(3,1 cm W x 7,1 cm H x 1,8 cm D)

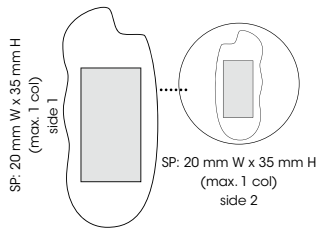

BIC® Squeeze:
(3,1 cm W x 7,1 cm H x 1,6 cm D)

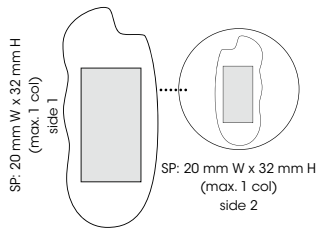

2390 BIC® Styl'it Fashion

2391 BIC® Squeeze



BIC® Styl'it Fashion



BIC® Squeeze

2390

- Trendy, hard plastic case

2391

- Silicone case
- Designed for comfort

Imprint

SP: body 1 colour

All cases are delivered with a transparent white lighter

2390

- Étui tendance en plastique rigide

2391

- Étui en plastique souple
- Ergonomique

Impression

SP: corps 1 couleur

Toutes nos coques sont livrées avec un briquet mini blanc translucide

2390

- Moderna funda de plástico rígido

2391

- Funda de silicona
- Diseñada para el confort

Impresión

SP: cuerpo 1 color

Todas las fundas incluyen un encendedor blanco transparente

2390

- Trendige Hülle aus gehärtetem Kunststoff

2391

- Weiche Kunststoffhülle
- Griffig und ergonomisch

Personalisierung

SP: Schaff 1 Farbe

Alle Hüllen werden mit einem transparent weissen J25mini Feuerzeug geliefert

2390

- Alla moda e di forte compattezza

2391

- Materiale di plastica soff
- Disegnato per il confort

Stampa

SP: corpo 1 colore

Tutti i copri accendini sono forniti con l'accendino bianco frosted

Min Qty: 100 units

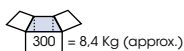

Standard packaging:

boxes of 50 u. / cartons de 50 u. / cajas de 50 u. / 50er Stück pro Karton / scatola da 50 pezzi



pg 162

Please refer to page 4 for icon definitions.

www.bicgraphic.com 125

Colours



BIC® C2 Metal:
(3,2 cm W x 7,8 cm H x 1,9 cm D)

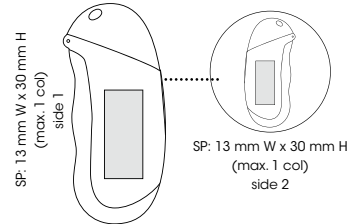

2382 Case

- Fits comfortably in hand

Imprint

SP: body 1 colour

All cases are delivered with a transparent white lighter

- Bonne prise en main

Impression

SP: corps 1 couleur

Toutes nos coques sont livrées avec un briquet mini blanc translucide

- Cabe confortablemente en la mano

Impresión

SP: cuerpo 1 color

Todas las fundas incluyen un encendedor blanco transparente

- Ergonomisches Design mit edlem Look

Personalisierung

SP: Schaff 1 Farbe

Alle Hüllen werden mit einem transparent weissen J25mini Feuerzeug geliefert

- Comodo e maneggevole

Stampa

SP: corpo 1 colore

Tutti i copri accendini sono forniti con l'accendino bianco frosted



Colours



BIC® Styl'it Luxury:
(2,3 cm W x 6,0 cm H x 1,2 cm D)

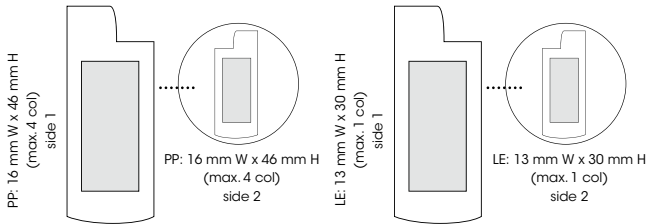

2381 Case

• Premium metal design

• Aspect métal haut de gamme

• Diseño premium de metal

• Hochwertige Metallhülle - der Klassiker

• Disegno di metallo eccellente

Imprint

PD: body up to 4 colours
LE: body 1 colour

All cases are delivered with a transparent white lighter

Impression

PD: corps jusqu'à 4 couleurs
LE: corps 1 couleur

Toutes nos coques sont livrées avec un briquet mini blanc translucide

Impresión

PD: cuerpo hasta 4 colores
LE: cuerpo 1 color

Todas las fundas incluyen un encendedor blanco transparente

Personalisierung

PD: Schaff max. 4 Farben
LE: Schaff 1 Farbe

Alle Hüllen werden mit einem transparent weissen J25mini Feuerzeug geliefert

Stampa

PD: corpo max. 4 colori
LE: corpo 1 colore

Tutti i copri accendini sono forniti con l'accendino bianco frosted

Min Qty: 100 units

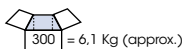

= 6,1 Kg (approx.)

Standard packaging:

boxes of 10 u. / cartons de 10 u. / cajas de 10 u. / 10er Stück pro Karton / scatola da 10 pezzi



pg 162

Please refer to page 4 for icon definitions.

BIC® lighters Not only a leader in quality!

HIGH QUALITY

- As provided by European regulation each BIC® Child-resistant lighter complies with ISO 9994 safety standard and EN 13869 standard⁽¹⁾
- Every BIC® lighter undergoes more than 50 quality checks

HIGH PERFORMANCE

- Each BIC® lighter is designed to provide thousands of lights and a long, safe, reliable use
- Each BIC® maxi lighter provides 3000 lights twice as many lights as other lighters of the same outer dimensions



USER FRIENDLY

- Igniting BIC® Child-resistant lighters requires just one single action

NICE DESIGN

- The shape of BIC® lighters has been studied to fit well in the consumers hand



⁽¹⁾ EN A Child-resistant lighter is not a child proof lighter. A Child-resistant lighter is a lighter that at least 85% of children under the age of 51 months cannot operate. This means that up to 15% of children may still be able to operate such a lighter. Therefore, adults should always ensure that young children cannot get hold of lighters, even if they are Child-resistant.

FR Un briquet "sécurité enfants" n'est pas un briquet exempt de tout risque pour les enfants: c'est un briquet que 85% au moins des enfants de moins de 51 mois ne peuvent pas faire fonctionner, ce qui implique que la proportion des enfants en cause capables de l'actionner peut aller jusqu'à 15%. Les adultes doivent donc toujours veiller à ce que les briquets soient hors de portée des enfants, même s'il s'agit de briquets « sécurité enfants ».

ES No es lo mismo un encendedor con seguridad para niños que un encendedor a prueba de niños. Por "encendedor con seguridad para niños" se entiende un encendedor que para un mínimo del 85% de los niños de hasta 51 meses de edad resulta imposible de accionar. Esto significa que hasta un 15% de los niños sí podrían hacer funcionar el encendedor. De ahí que los adultos deban siempre impedir que los niños jueguen con encendedores, por seguros que éstos sean.

DE Ein kindergesichertes Feuerzeug ist nicht unbedingt kindersicher. Als "kindergesichert" bezeichnet man Feuerzeuge, die von mindestens 85% der Kinder unter 51 Monaten nicht bedient werden können. Das bedeutet, dass bis zu 15% der Kinder diese Feuerzeuge möglicherweise bedienen können. Daher müssen Sie Feuerzeuge – auch wenn sie kindergesichert sind – stets außerhalb der Reichweite von Kleinkindern aufbewahren.

IT Un accendino dotato di dispositivo di sicurezza per i bambini non è un accendino a prova di bambino. Infatti, un accendino sicuro per i bambini è un accendino che almeno l'85% dei bambini di età inferiore a 51 mesi non è in grado di far funzionare. Ciò significa però che ben il 15% dei bambini potrebbe essere capace di azionare questo tipo di accendini. Per tale motivo, gli adulti dovrebbero sempre fare in modo che i bambini non possano impadronirsi di accendini, nemmeno qualora siano dotati di un dispositivo di sicurezza per i bambini.



Briquets BIC®, pas seulement leader en terme de qualité!

QUALITÉ

- Comme requis par la réglementation européenne, chaque briquet BIC® «sécurité enfants» est conforme à la norme de sécurité ISO 9994 et à la norme EN 13869 (1).
- Chaque briquet BIC® est soumis à plus de 50 contrôles qualité.

PERFORMANCE

- Chaque briquet BIC® est conçu pour offrir des milliers de flammes et une utilisation fiable de longue durée.
- Un briquet BIC® maxi offre 3.000 allumages, deux fois plus que de nombreux briquets ayant les mêmes dimensions extérieures.

CONFORT D'UTILISATION

- L'allumage d'un briquet BIC® «sécurité enfants» ne requiert qu'une seule action.

DESIGN

- La forme des briquets BIC® a été étudiée pour une prise en main optimum par les consommateurs.

Encendedores BIC®, ¡más que un líder en calidad!

GRAN CALIDAD

- Según se establece en la legislación europea, cada encendedor BIC® con seguridad para niños cumple con la norma de seguridad ISO 9994 y con la norma EN 13869 (1).
- Cada encendedor BIC® se somete a más de 50 controles de calidad.

ALTO RENDIMIENTO

- Cada encendedor BIC® está diseñado para encenderse miles de veces y ofrecer un uso duradero, seguro y fiable.
- Cada encendedor BIC® Maxi proporciona 3.000 encendidos, el doble que otros encendedores del mismo tamaño.

FÁCIL DE USAR

- Para encender los encendedores BIC® seguros para niños sólo hace falta un movimiento.

DISEÑO AGRADABLE

- La forma de los encendedores BIC® ha sido concebida para adaptarse bien a la mano de los consumidores.

BIC® Feuerzeuge nicht nur in Sachen Qualität führend!

HOHE QUALITÄT

- Entsprechend der EU-Regelung erfüllt jedes kindergesicherte BIC® Feuerzeug die Sicherheitsnorm ISO 9994 und die Norm EN 13869 (1).
- Jedes BIC® Feuerzeug wird mehr als 50 Qualitätskontrollen unterzogen

LEISTUNGSFÄHIG

- Jedes BIC® Feuerzeug ist auf mehrere tausend Zündungen und einen langen, sicheren, zuverlässigen Gebrauch ausgerichtet.
- Jedes BIC® Maxi-Feuerzeug bietet 3.000 Zündungen, d. h. doppelt so viele wie zahlreiche Feuerzeuge mit den gleichen Außenmaßen.

BENUTZERFREUNDLICH

- Kindergesicherte BIC® Feuerzeuge können mit einer einzigen Bewegung gezündet werden.

SCHÖNES DESIGN

- Die Form von BIC® Feuerzeugen ist so konzipiert, dass sie gut in der Hand liegen.

Accendini BIC®, leader non solo in qualità!

ALTA QUALITÀ

- Come indicato dalla normativa europea, ogni accendino BIC® dotato di dispositivo di sicurezza è conforme alla norma ISO 9994 e alla norma EN 13869(1).
- Ogni accendino BIC® viene sottoposto a più di 50 controlli qualità.

ALTE PRESTAZIONI

- Ogni accendino BIC® è progettato per essere acceso migliaia di volte e per garantire un uso prolungato, affidabile e sicuro.
- Un accendino BIC® maxi permette 3.000 accensioni, due volte di più rispetto a molti accendini che presentano le stesse dimensioni esterne.

FACILITÀ DI UTILIZZO

- L'accensione di un accendino BIC® dotato di dispositivo di sicurezza richiede una sola operazione.

DESIGN

- La forma degli accendini BIC® è stata studiata per adattarsi alla mano del consumatore.

Ecolutions Ecolutions Ecolutions Ecolutions Ecolutions

BIC® Ecolutions™ Round Stic™	132	BIC® Ecolutions™ Clic	143
BIC® Ecolutions™ Media Clic	133	BIC® Ecolutions™ Clic Gold	144
BIC® Ecolutions™ Clic Stic™	134	BIC® Ecolutions™ Evolution™ Classic	145
BIC® Ecolutions™ Clic Stic™ Digital	135	BIC® Ecolutions™ Evolution™ Digital	146
BIC® Ecolutions™ Tri Stic™	136	BIC® Ecolutions™ Evolution™ Colour Connection	147
BIC® Ecolutions™ Media Clic Grip	137	BIC® Ecolutions™ Evolution™ Digital Colour Connection	148
BIC® Ecolutions™ Media Clic Grip Digital	138	BIC® Chipbpard Notebook With Recycled Fiber	149
BIC® Ecolutions™ Wide Body™	139	BIC® Ecolutions™ How It's Made	150
BIC® Ecolutions™ Wide Body™ Digital	140	BIC® Ecolutions™ Sticky Notes Info on Paper Stock	151
BIC® Ecolutions™ Media Max	141		
BIC® Ecolutions™ Media Max Digital	142		



 **BIC**[®] **ecolutions**[™]



Cap, Section and Plug
Opaque

02 03 07 20



Barrel
Opaque

01

Barrel
Frosted

69



Plastic parts are acquired from manufacturing facilities to be reused and not discarded



Plastic parts are flated, mixed and melted



The final result is pre-consumer recycled plastic pellets to make BIC® Ecolutions™ pens

(pg 150)



We offer our clients the option to include the "mobius loop" in the imprint area of the barrel with one of the colours used in the logo at no extra cost. The recycled symbol will default to the lower left hand corner of the imprint, unless otherwise specified.

BIC® Ecolutions™ Round Stic™:
(1,8 cm W x 15 cm H)

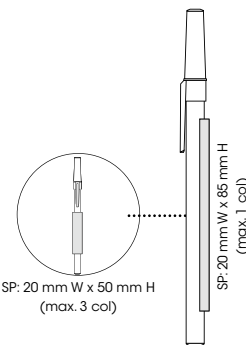

1E10 Ballpen/ Bille / Bolígrafo / Kugelschreiber / Sfera

• Patented ventilated cap design

• Capuchon ventilé breveté

• Diseño de ventilación del tapón patentado

• Patentiertes Kappendesign

• Cappuccio brevettato con fori di ventilazione

Imprint

SP: barrel up to 3 colours

Impression

SP: corps jusqu'à 3 couleurs

Impresión

SP: cuerpo hasta 3 colores

Personalisierung

SP: Schaft max. 3 Farben

Stampa

SP: corpo max. 3 colori

* Made with 70% recycled material.
The percentage is calculated on the total weight of the product.



M

●

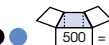

= 2.5 Kg (approx.)



Plug and Clip

Opaque



Frosted



Barrel

Opaque



Plastic parts are acquired from manufacturing facilities to be reused and not discarded (pg 150)



Plastic parts are flated, mixed and melted



The final result is pre-consumer recycled plastic pellets to make BIC® Ecollections™ pens

We offer our clients the option to include the "mobius loop" in the imprint area of the barrel with one of the colours used in the logo at no extra cost. The recycled symbol will default to the lower left hand corner of the imprint, unless otherwise specified.



BIC® Ecollections™ Media Clic:
(1,3 cm W x 14,7 cm H)

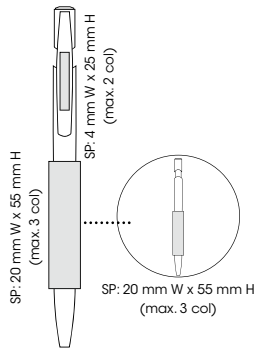

- 1E25** Ballpen / Bille / Bolígrafo / Kugelschreiber / Sfera
- 1E28** Pencil / Porte-mines / Porta minas / Druckbleistift / Portamine

- A classic in simplicity and quality
 - Un classique de simplicité et de qualité
 - Un clásico en simplicidad y calidad
 - Schlicht und hochwertig
 - Un classico in semplicità e qualità
- Imprint**
SP: clip up to 2 colours / barrel up to 3 colours
- Impression**
SP: clip jusqu'à 2 couleurs / corps jusqu'à 3 couleurs
- Impresión**
SP: clip hasta 2 colores / cuerpo hasta 3 colores
- Personalisierung**
SP: Clip max. 2 Farben / Schaff max. 3 Farben
- Stampa**
SP: clip max. 2 colori / corpo max. 3 colori

* Made with 39% recycled material.
The percentage is calculated on the total weight of the product.

Min Qty: 500 units M ● ● \varnothing 0,7 mm 500 = 4,1 Kg (approx.)

BIC® Easy-Glide Ink™ or
BIC® Fraud Defense Ink™ option



pg 162

Please refer to page 4 for icon definitions.



Section/Clip
Opaque

02 03 07 20



Barrel
Opaque

01

Frosted

69



Plastic parts are acquired from manufacturing facilities to be reused and not discarded



Plastic parts are fluted, mixed and melted



The final result is pre-consumer recycled plastic pellets to make BIC® Ecolutions™ pens

(pg 150)



We offer our clients the option to include the "mobius loop" in the imprint area of the barrel with one of the colours used in the logo at no extra cost. The recycled symbol will default to the lower left hand corner of the imprint, unless otherwise specified.

BIC® Ecolutions™ Clic Stic™:
(1,3 cm W x 14 cm H)

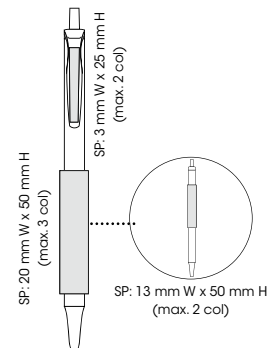

1E00 Ballpen/ Bille / Bolígrafo / Kugelschreiber / Sfera

• Break resistant pocket clip

• Clip ultra resistant

• Clip de bolsillo irrompible

• Bruchsicherer Clip

• Clip resistente a rotture

Imprint

SP: clip up to 2 colours / barrel up to 3 colours

Impression

SP: clip jusqu'à 2 couleurs / corps jusqu'à 3 couleurs

Impresión

SP: clip hasta 2 colores / cuerpo hasta 3 colores

Personalisierung

SP: Clip max. 2 Farben / Schaft max. 3 Farben

Stampa

SP: clip max. 2 colori / corpo max. 3 colori

* Made with 59% recycled material.

The percentage is calculated on the total weight of the product.

Section/Clip
Opaque



Barrel
Opaque



Plastic parts are acquired from manufacturing facilities to be reused and not discarded (pg 150)

Plastic parts are flated, mixed and melted

The final result is pre-consumer recycled plastic pellets to make BIC® Ecolutions™ pens

We offer our clients the option to include the "mobius loop" in the imprint area of the barrel with one of the colours used in the logo at no extra cost. The recycled symbol will default to the lower left hand corner of the imprint, unless otherwise specified.



BIC® Ecolutions™ Clic Stic™ Digital:
(1,3 cm W x 14 cm H)

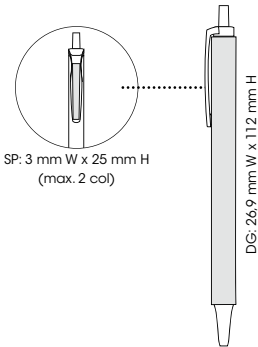

1E01 Ballpen/ Bille / Bolígrafo / Kugelschreiber / Sfera

• Ability to print full color images

• Imprimez vos visuels en haute définition

• Posibilidad de imprimir imágenes a todo color

• Vollfarbige Bilder werden Realität

• Possibilità di stampare immagini in quadricromia digitale

Imprint
DG: barrel
SP: clip up to 2 colours

Impression
DG: corps
SP: clip jusqu'à 2 couleurs

Impresión
DG: cuerpo
SP: clip hasta 2 colores

Personalisierung
DG: Schaff
SP: Clip max. 2 Farben

Stampa
DG: corpo
SP: clip max. 2 colori

* Made with 59% recycled material.
The percentage is calculated on the total weight of the product.

Min Qty.: 500 units = 2,6 Kg (approx.)

pg 162

Please refer to page 4 for icon definitions.



Barrel / Ink
Opaque

01

Trims

02

07



Plastic parts are acquired from manufacturing facilities to be reused and not discarded



Plastic parts are flated, mixed and melted



The final result is pre-consumer recycled plastic pellets to make BIC® Ecolutions™ pens

(pg 150)



We offer our clients the option to include the "mobius loop" in the imprint area of the barrel with one of the colours used in the logo at no extra cost. The recycled symbol will default to the lower left hand corner of the imprint, unless otherwise specified.

BIC® Ecolutions™ Tri Stic™:
(1,27 cm W x 13,8 cm H)

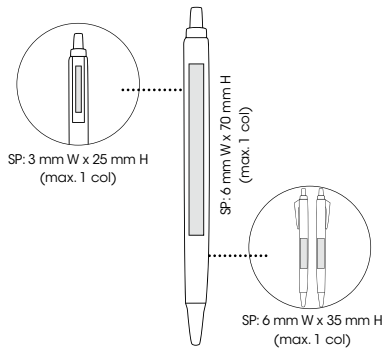

1072 Ballpen/ Bille / Bolígrafo / Kugelschreiber / Sfera

• 3-sided barrel, 3 different imprint areas available for maximum communication

• Corps triangulaire personnalisable sur les 3 faces pour une communication maximale

• Cuerpo de 3 lados, 3 áreas de impresión diferentes para una máxima comunicación

• 3 Druckflächen auf 3-kantigem Schaft für eine maximale Werbewirkung

• 3 corpo trifacciale, 3 differenti aree di stampa utilizzabili per una massima comunicazione

Imprint
SP: barrel and clip up to 1 colour

Impression
SP: corps et clip jusqu'à 1 couleur

Impresión
SP: cuerpo y clip hasta 1 color

Personalisierung
SP: Schaft und Clip 1 Farbe

Stampa
SP: corpo e clip max 1 colore

* Made with 71% recycled material.
The percentage is calculated on the total weight of the product.



Plug and Clip

Opaque



Frosted



Only for plug and clip

Barrel
Opaque



Grip
Opaque



Plastic parts are acquired from manufacturing facilities to be reused and not discarded (pg 150)



Plastic parts are flated, mixed and melted



The final result is pre-consumer recycled plastic pellets to make BIC® Ecolutions™ pens

We offer our clients the option to include the "mobius loop" in the imprint area of the barrel with one of the colours used in the logo at no extra cost. The recycled symbol will default to the lower left hand corner of the imprint, unless otherwise specified.



BIC® Ecolutions™ Media Clic Grip:
(1,3 cm W x 14,7 cm H)

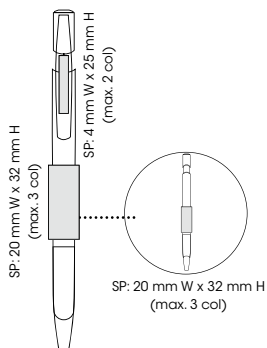

- 1E20** Ballpen / Bille / Bolígrafo / Kugelschreiber / Sfera
- 1E21** Pencil / Porte-mines / Porta minas / Druckbleistift / Portamine

• Comfortable gripping section

• Zone de préhension confortable

• Grip moderno y confortable

• Angenehm weiche Griffzone

• Sezione e grip confortevoli

Imprint

SP: barrel up to 3 colours / clip up to 2 colours

Impression

SP: corps jusqu'à 3 couleurs / clip jusqu'à 2 couleurs

Impresión

SP: cuerpo hasta 3 colores / clip hasta 2 colores

Personalisierung

SP: Schaft max. 3 Farben / Clip max. 2 Farben

Stampa

SP: corpo max. 3 colori / clip max. 2 colori

* Made with 37% recycled material.

The percentage is calculated on the total weight of the product.

Min Qty.: 500 units



●

●



Ø 0,7 mm



= 4,3 Kg (approx.)

BIC® Easy-Glide Ink™ option



pg 162

Please refer to page 4 for icon definitions.



Plug and Clip
Opaque

- 01
- 02
- 2B
- 03
- 04
- 05
- 07
- 10
- 12
- 13
- 18
- 29

Frosted
69



Only for plug and clip

Barrel
Opaque

- 01

Grip
Opaque

- 02
- 03
- 05
- 07
- 12



Plastic parts are acquired from manufacturing facilities to be reused and not discarded



Plastic parts are flated, mixed and melted



The final result is pre-consumer recycled plastic pellets to make BIC® Evolutions™ pens

(pg 150)



We offer our clients the option to include the "mobius loop" in the imprint area of the barrel with one of the colours used in the logo at no extra cost. The recycled symbol will default to the lower left hand corner of the imprint, unless otherwise specified.

BIC® Evolutions™ Media Clic Grip Digital:
(1,3 cm W x 14 cm H)

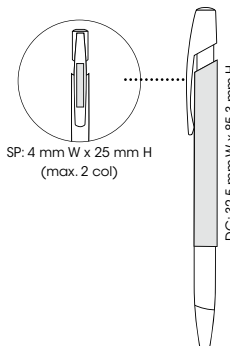

1E22 Ballpen / Bille / Bolígrafo / Kugelschreiber / Sfera

1E23 Pencil / Porte-mines / Porta minas / Druckbleistift / Portamine

• Ability to print full color images

• Imprimez vos visuels en haute définition

• Posibilidad de imprimir imágenes a todo color

• Vollfarbige Bilder werden Realität

• Possibilità di stampare immagini in quadricromia digitale

Imprint
DG: barrel
SP: clip up to 2 colours

Impression
DG: corps
SP: clip jusqu'à 2 couleurs

Impresión
DG: cuerpo
SP: clip hasta 2 colores

Personalisierung
DG: Schaft
SP: Clip max. 2 Farben

Stampa
DG: corpo
SP: clip max. 2 colori

* Made with 37% recycled material.
The percentage is calculated on the total weight of the product.



pg 162

Please refer to page 4 for icon definitions.

Min Qty.: 500 units M \varnothing 0,7 mm 500 = 4,3 Kg (approx.)

Clip and Section
Opaque

- 01 02 03 07 18

Frosted

- 40 63 66 67
68 69 71



Barrel
Opaque

- 01



Plastic parts are acquired from manufacturing facilities to be reused and not discarded (pg 150)



Plastic parts are flated, mixed and melted



The final result is pre-consumer recycled plastic pellets to make BIC® Ecolutions™ pens

We offer our clients the option to include the "mobius loop" in the imprint area of the barrel with one of the colours used in the logo at no extra cost. The recycled symbol will default to the lower left hand corner of the imprint, unless otherwise specified.



BIC® Ecolutions™ Wide Body™:
(1,6 cm W x 14,2 cm H)

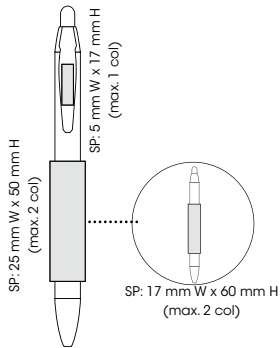

1E80 Ballpen / Bille / Bolígrafo / Kugelschreiber / Sfera

• Wide-profile design with large imprint area

• Profil large avec large zone d'impression

• Diseñado para maximizar el área de impresión

• Klassisches Design mit großer Druckfläche

• Profilo ampio con grande area di personalizzazione

Imprint

SP: clip 1 colour / barrel up to 2 colours

Impression

SP: clip 1 couleur / corps jusqu'à 2 couleurs

Impresión

SP: clip 1 color / cuerpo hasta 2 colores

Personalisierung

SP: Clip 1 Farbe / Schaff max. 2 Farben

Stampa

SP: clip 1 colore / corpo max. 2 colori

* **Made with 34% recycled material.**
The percentage is calculated on the total weight of the product.

Min Qty.: 250 units = 2,6 Kg (approx.)

BIC® Easy-Glide Ink™ or BIC® Fraud Defense Ink™ option

pg 162

Please refer to page 4 for icon definitions.



Clip and Section
Opaque

- 01
- 02
- 03
- 07
- 18

Frosted

- 40
- 63
- 66
- 67
- 68
- 69
- 71

Barrel
Opaque

- 01



Plastic parts are acquired from manufacturing facilities to be reused and not discarded



Plastic parts are flated, mixed and melted



The final result is pre-consumer recycled plastic pellets to make BIC® Ecolutions™ pens

(pg 150)



We offer our clients the option to include the "mobius loop" in the imprint area of the barrel with one of the colours used in the logo at no extra cost. The recycled symbol will default to the lower left hand corner of the imprint, unless otherwise specified.

BIC® Ecolutions™ Wide Body™ Digital:
(1,6 cm W x 14,2 cm H)

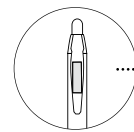

SP: 5 mm W x 17 mm H
(max. 1 col)



DG: image area: 107 mm x 35,5 mm
DG: text area: 99 mm x 32 mm

1E81 Ballpen / Bille / Bolígrafo / Kugelschreiber / Sfera

• Ability to print full color images

• Imprimez vos visuels en haute définition

• Posibilidad de imprimir imágenes a todo color

• Vollfarbige Bilder werden Realität

• Possibilità di stampare immagini in quadricromia digitale

Imprint
DG: barrel
SP: clip 1 colour

Impression
DG: corps
SP: clip 1 couleur

Impresión
DG: cuerpo
SP: clip 1 color

Personalisierung
DG: Schaft
SP: Clip 1 Farbe

Stampa
DG: corpo
SP: clip 1 colore

* Made with 34% recycled material.
The percentage is calculated on the total weight of the product.



Plug, Clip and Section
Opaque



Frosted

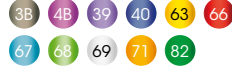

Barrel
Opaque



Plastic parts are acquired from manufacturing facilities to be reused and not discarded (pg 150)



Plastic parts are flated, mixed and melted



The final result is pre-consumer recycled plastic pellets to make BIC® Ecolutions™ pens

We offer our clients the option to include the "mobius loop" in the imprint area of the barrel with one of the colours used in the logo at no extra cost. The recycled symbol will default to the lower left hand corner of the imprint, unless otherwise specified.



BIC® Ecolutions™ Media Max:
(1,35 cm W x 14,3 cm H)

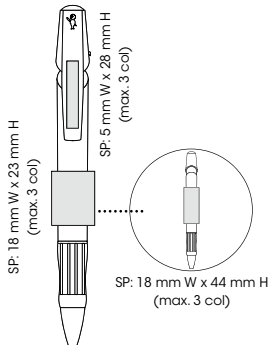

- 1E30** Ballpen / Bille / Bolígrafo / Kugelschreiber / Sfera
- 1E33** Pencil / Porte-mines / Porta minas / Druckbleistift / Portamine

- Soft, sleek gripping section
- Extra wide barrel for maximum imprint area

- Partie grip lisse et douce
- Corps extra large pour une surface de marquage maximale

- Grip suave
- Cuerpo extra ancho para una zona máxima de impresión

- Angenehm weiche Griffzone
- Extra breiter Schaft für eine maximale Werbefläche

- Grip morbida
- Corpo extra largo per una superficie di stampa massima

Imprint
SP: clip up to 3 colours / barrel up to 3 colours

Impression
SP: clip jusqu'à 3 couleurs / corps jusqu'à 3 couleurs

Impresión
SP: clip hasta 3 colores / cuerpo hasta 3 colores

Personalisierung
SP: Clip max. 3 Farben / Schaft max. 3 Farben

Stampa
SP: clip max. 3 colori / corpo max. 3 colori

* **Made with 26% recycled material.**
The percentage is calculated on the total weight of the product.

Min Qty.: 500 units M Ø 0,7 mm = 6 Kg (approx.)

BIC® Easy-Glide Ink™ or BIC® Fraud Defense Ink™ option



pg 162

Please refer to page 4 for icon definitions.



Plug, Clip, Grip and Section

Opaque



Frosted

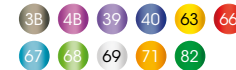

Barrel

Opaque



Plastic parts are acquired from manufacturing facilities to be reused and not discarded



Plastic parts are flated, mixed and melted



The final result is pre-consumer recycled plastic pellets to make BIC® Ecolutions™ pens

(pg 150)



We offer our clients the option to include the "mobius loop" in the imprint area of the barrel with one of the colours used in the logo at no extra cost. The recycled symbol will default to the lower left hand corner of the imprint, unless otherwise specified.

BIC® Ecolutions™ Media Max Digital:
(1,35 cm W x 14,3 cm H)

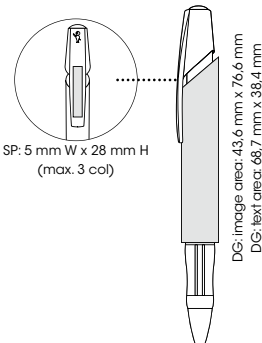

1E34 Ballpen / Bille / Bolígrafo / Kugelschreiber / Sfera

1E35 Pencil / Porte-mines / Porta minas / Druckbleistift / Portamine

- Soft, sleek gripping section
- Extra wide barrel for maximum imprint area

- Partie grip lisse et douce
- Corps extra large pour une surface de marquage maximale

- Grip suave
- Cuerpo extra ancho para una zona máxima de impresión

- Angenehm weiche Griffzone
- Extra breiter Schaft für eine maximale Werbefläche

- Grip morbida
- Corpo extra largo per una superficie di stampa massima

Imprint

SP: clip up to 3 colours
DG: barrel

Impression

SP: clip jusqu'à 3 couleurs
DG: corps

Impresión

SP: clip hasta 3 colores
DG: cuerpo

Personalisierung

SP: Clip max. 3 Farben
DG: Schaft

Stampa

SP: clip max. 3 colori
DG: corpo

* Made with 26% recycled material.
The percentage is calculated on the total weight of the product.

**Barrel / Ink
Opaque**



Clip/Trims

35



Wood is collected from softwood and sustainably managed forests (pg 150)

Bark is used as fuel to convert the wood chips into a renewable plastic

* The final result is plastic pellets, made from a renewable resource, used to make BIC® Clic pens

BIC® Ecolutions™ Clic:
(1,1 cm W x 14,5 cm H)

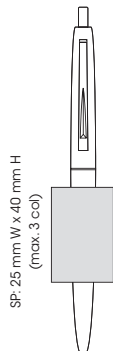

1090 Ballpen / Bille / Bolígrafo / Kugelschreiber / Sfera

• Made of 25% plastic from a renewable resource

• Fabriqué à base de 25% de plastique provenant de ressources renouvelables

• Hecho de un 25% de plástico procedente de recursos renovables

• Hergestellt mit 25% Kunststoff aus erneuerbaren Rohstoffen

• Prodotto con il 25% di plastica proveniente da risorse rinnovabili

Imprint

SP: barrel up to 3 colours

Impression

SP: corps jusqu'à 3 couleurs

Impresión

SP: cuerpo hasta 3 colores

Personalisierung

SP: Schaff max. 3 Farben

Stampa

SP: corpo max. 3 colori

Min Qty.: 250 units



= 2,3 Kg (approx.)

BIC® Fraud Defense Ink™ option



Except for 34



pg 162

Please refer to page 4 for icon definitions.



Barrel / Ink
Opaque



Clear



Clip/Trims



Wood is collected from softwood forests and replanted (pg 150)



Bark is used as fuel to convert the wood chips into a renewable plastic



* The final result is plastic pellets, made from a renewable resource, used to make BIC® Clic pens

BIC® Ecolutions™ Clic Gold:
(1,1 cm W x 14,5 cm H)

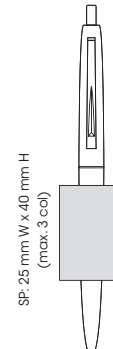

1091 Ballpen / Bille / Bolígrafo / Kugelschreiber / Sfera

• Made of 25% plastic from a renewable resource

• Fabriqué à base de 25% de plastique provenant de ressources renouvelables

• Hecho de un 25% de plástico procedente de recursos renovables

• Hergestellt mit 25% Kunststoff aus erneuerbaren Rohstoffen

• Prodotto con il 25% di plastica proveniente da risorse rinnovabili

Imprint

SP: barrel up to 3 colours

Impression

SP: corps jusqu'à 3 couleurs

Impresión

SP: cuerpo hasta 3 colores

Personalisierung

SP: Schaff max. 3 Farben

Stampa

SP: corpo max. 3 colori

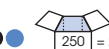

Barrel
Opaque



Plastic is collected from homes, schools and businesses for recycling

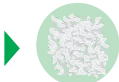

Plastic parts are acquired from manufacturing facilities to be reused and not discarded



Plastic parts are flated, mixed and melted

The final result is pre-consumer recycled plastic pellets to make BIC® Ecolutions™ pencils

(pg 150)

We offer our clients the option to include the "mobius loop" in the imprint area of the barrel with one of the colours used in the logo at no extra cost. The recycled symbol will default to the lower left hand corner of the imprint, unless otherwise specified.



BIC® Ecolutions™ Evolution™ Classic:
(0,73 cm W x 18,3 cm H)

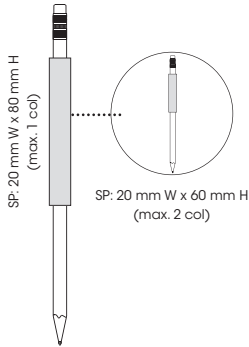

- 1150** Cut End/ Bout coupé /Extremos Cortados / Ohne Radiergummi / Senza gomma
- 1151* Eraser/ Bout Gomme /Goma / Mit Radiergummi / Con gomma

• Synthetic resin and wood-free	• Résine synthétique et sans bois	• Resina sintética que no contiene madera	• Kunstharz und holzfrei	• Resina sintetica senza fibra legnosa
Imprint SP: barrel up to 2 colours	Impression SP: corps jusqu'à 2 couleurs	Impresión SP: cuerpo hasta 2 colores	Personalisierung SP: Schaft max. 2 Farben	Stampa SP: corpo max. 2 colori

** Made with 54% pre-consumer recycled plastic (BIC® Ecolutions™ Evolution® Classic / Cut End)
* Made with 46% pre-consumer recycled plastic (BIC® Ecolutions™ Evolution® Classic / Eraser)
The percentage is calculated on the total weight of the product.

Min Qty.: 500 units = 3.5 Kg (approx.)



Only cut end & not sharpened pg 162

Please refer to page 4 for icon definitions.



Barrel Opaque

01

Plastic is collected from homes, schools and businesses for recycling



Plastic parts are acquired from manufacturing facilities to be reused and not discarded



Plastic parts are flated, mixed and melted

The final result is pre-consumer recycled plastic pellets to make BIC® Ecolutions™ pencils

(pg 150)



We offer our clients the option to include the "mobius loop" in the imprint area of the barrel with one of the colours used in the logo at no extra cost. The recycled symbol will default to the lower left hand corner of the imprint, unless otherwise specified.

**

BIC® Ecolutions™ Evolution™ Digital:
(0,73 cm W x 18,3 cm H)

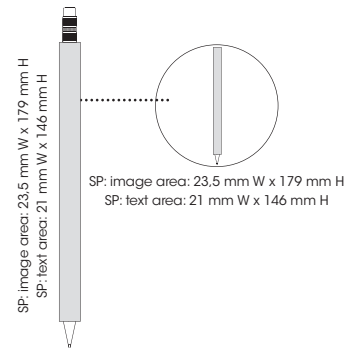

- 1879*** Cut End/ Bout coupé /Extremos Cortados / Ohne Radiergummi / Senza gomma
- 1871**** Eraser/ Bout Gomme /Goma / Mit Radiergummi / Con gomma

• Synthetic resin and wood-free

• Résine synthétique et sans bois

• Resina sintética que no contiene madera

• Kunstharz und holzfrei

• Resina sintetica senza fibra legnosa

Imprint
DG: barrel

Impression
DG: corps

Impresión
DG: cuerpo

Personalisierung
DG: Schaft

Stampa
DG: corpo

* Made with 46% pre-consumer recycled plastic (BIC® Ecolutions™ Evolution® Digital / Cut End)
** Made with 54% pre-consumer recycled plastic (BIC® Ecolutions™ Evolution® Digital / Eraser)
The percentage is calculated on the total weight of the product.



Barrel
Opaque

- 01
- 02
- 03
- 04
- 07
- 20



Eraser

- 01
- 02
- 07
- 10
- 12
- 14
- 59

Ferrule

- 02
- 2C
- 26
- 34
- 47

Plastic is collected from homes, schools and businesses for recycling



Plastic parts are acquired from manufacturing facilities to be reused and not discarded



Plastic parts are flated, mixed and melted

The final result is pre-consumer recycled plastic pellets to make BIC® Ecolutions™ pencils

(pg 150)

We offer our clients the option to include the "mobius loop" in the imprint area of the barrel with one of the colours used in the logo at no extra cost. The recycled symbol will default to the lower left hand corner of the imprint, unless otherwise specified.



BIC® Ecolutions™ Evolution™ Colour Connection:
(0,73 cm W x 18,3 cm H)

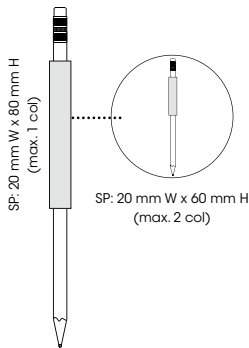

1154 Eraser / Bout Gomme / Goma / Mit Radiergummi / Con gomma

• Synthetic resin and wood-free

• Résine synthétique et sans bois

• Resina sintética que no contiene madera

• Kunstharz und holzfrei

• Resina sintetica senza fibra legnosa

Imprint

SP: barrel up to 2 colours

Impression

SP: corps jusqu'à 2 couleurs

Impresión

SP: cuerpo hasta 2 colores

Personalisierung

SP: Schaft max. 2 Farben

Stampa

SP: corpo max. 2 colori

* Made with 46% pre-consumer recycled plastic.
The percentage is calculated on the total weight of the product.

Min Qty.: 2500 units



= 3.5 Kg (approx.)



pg 162

Please refer to page 4 for icon definitions.



Opaque

01



Eraser

01

02

07

10

12

14

59

Ferrule

02

2C

26

34

47

Plastic is collected from homes, schools and businesses for recycling



Plastic parts are acquired from manufacturing facilities to be reused and not discarded



Plastic parts are flated, mixed and melted

The final result is pre-consumer recycled plastic pellets to make BIC® Evolutions™ pencils

(pg 150)



We offer our clients the option to include the "mobius loop" in the imprint area of the barrel with one of the colours used in the logo at no extra cost. The recycled symbol will default to the lower left hand corner of the imprint, unless otherwise specified.

BIC® Evolutions™ Evolutions™ Digital Colour Connection:
(0,73 cm W x 18,3 cm H)



1885 Eraser / Bout Gomme / Goma / Mit Radiergummi / Con gomma

• Synthetic resin and wood-free

• Résine synthétique; ne contient pas de bois

• Resina sintética

• Aus Kunstharz; holzfrei

• Resina sintetica

Imprint
DG: barrel

Impression
DG: corps

Impresión
DG: cuerpo

Personalisierung
DG: Schaft

Stampa
DG: corpo

* Made with 46% pre-consumer recycled plastic. The percentage is calculated on the total weight of the product.

pg 162

Please refer to page 4 for icon definitions.

Min Qty.: 2500 units PC 500 = 3,5 Kg (approx.)



6E

BIC® Chipboard Notebook with Recycled Fiber:
(12,5 cm W x 17,5 cm H)

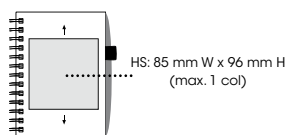

3715 Recycled Fiber / Fibres recyclées / Fibra reciclada /
Allpapierfasern/ fibra riciclata

- "Mobius loop" symbol preprinted on inner sheets
- Popular natural finish

- Symbole de la boucle de "Möbius pré-imprimé" sur les feuilles internes
- Finitions naturelles courante

- Símbolo "Mobius loop" preimpreso en las páginas interiores
- Popular acabado natural

- Vorgedruckte "Möbius-Schleife" auf allen Seiten
- In beliebter Naturausführung

- Il simbolo "Mobius loop" viene prestampato in ogni foglio
- Finitura naturale popolare

Standard Paper
All notebooks come with 100 sheet of lined 60g paper.

Papier standard
Chaque notebook comprend 100 feuilles de papier ligné de 60 g.

Papel estándar
Todos los cuadernos tienen 100 páginas de papel lineado de 60 g.

Standardpapier
Alle Notizbücher mit liniertem Papier 60g, 100 Blatt

Carta standard
Tutii i notebooks sono costituiti da 100 fogli a righe. Carta da 60 gr.

Imprint
HS: 1 colour

Impression
HS: 1 couleur

Impresión
HS: 1 color

Personalisierung
HS: 1 Farbe

Stampa
HS: 1 colore

*BIC® Chipboard Notebook is made with 88% Recycled Fiber

Min Qty: 50 units



= 6.2 Kg (approx.)

pg 162

Please refer to page 4 for icon definitions.

BIC® Ecolutions™ Round Stic® / BIC® Ecolutions™ Media Clic™ / BIC® Ecolutions™ Clic Stic® / BIC® Ecolutions™ Clic Stic® Digital / BIC® Ecolutions™ Tri Stic® / BIC® Ecolutions™ Media Clic™ Grip / BIC® Ecolutions™ Media Clic™ Grip Digital / BIC® Ecolutions™ Wide Body® / BIC® Ecolutions™ Wide Body® Digital / BIC® Ecolutions™ Media Max / BIC® Ecolutions™ Media Max Digital



(ENG) Plastic parts are acquired from manufacturing facilities to be reused and not discarded

(FRA) Des pièces en plastique sont acquises auprès d'installations industrielles en vue d'être réutilisées au lieu d'être mises au rebut

(ESP) Las piezas de plástico son obtenidas de nuestro proceso de fabricación para ser reutilizadas y no desechadas

(DEU) Der Hersteller kauft wiederverwendbaren Kunststoff

(ITA) I componenti plastici sono acquistati da scarti produzione per essere riutilizzati



(ENG) Plastic parts are flated, mixed and melted

(FRA) Les pièces en plastique sont alors aplaties, mélangées et fondues.

(ESP) Las piezas de plástico son troceadas, mezcladas y derretidas

(DEU) Der Kunststoff wird gepresst, vermisch und geschmolzen

(ITA) I componenti plastici sono mixati, lisciati e fusi

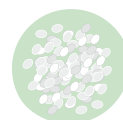

(ENG) The final result is pre-consumer recycled plastic pellets to make BIC® Ecolutions™ pens

(FRA) Le résultat final au stade pré-consommateur consiste en des granulés de plastique destinés à fabriquer des stylos BIC® Ecolutions™

(ESP) El resultado final es un granulado de plástico reciclado pre-consumidor que se utiliza para fabricar bolígrafos BIC® Ecolutions™

(DEU) Das Resultat ist pre-consumer (fabrikneues) Kunststoffgranulat zur Herstellung von BIC® Ecolutions™ Kugelschreiber

(ITA) Il risultato finale sono palline di plastica pre-utilizzate per ricreare nuove sfere BIC® Ecolutions™

BIC® Ecolutions™ Clic® Gold / BIC® Ecolutions™ Clic®



(ENG) Wood is collected from softwood and sustainably managed forests

(FRA) Le bois est collecté de forêts à bois doux gérées durablement

(ESP) La madera es recolectada de bosques sostenibles y de madera blanda

(DEU) Das Holz wird aus Weichholz sowie aus nachhaltig bewirtschafteten Wäldern gewonnen

(ITA) Il legno proviene da foreste che vengono in seguito ripiantate per una gestione sostenibile dell'ambiente



(ENG) Bark is used as fuel to convert the wood chips into a renewable plastic

(FRA) L'écorce est le carburant utilisé pour convertir les pièces de bois en plastique renouvelable

(ESP) La corteza es utilizada como combustible para convertir las astillas de madera en un plástico renovable

(DEU) Die Baumrinde wird als Brennstoff verwendet, um das Holzgranulat in recycelbaren Kunststoff umzuwandeln

(ITA) I trucioli di legno vengono utilizzati come combustibile per convertire il legno economico in plastica rinnovabile



(ENG) The final result is plastic pellets, made from a renewable resource, used to make BIC® Clic pens

(FRA) Le résultat final est des granulés de plastique d'origine renouvelable utilisés pour la production des stylos à bille BIC® Clic

(ESP) El resultado final es un granulado de plástico, hecho de un recurso renovable y utilizado para fabricar bolígrafos BIC® Clic

(DEU) Das Endergebnis ist ein Kunststoffgranulat, das aus einer erneuerbaren Ressource gewonnen und zur Herstellung von BIC® Clic Kugelschreibern verwendet wird

(ITA) Il risultato finale sono le palline di plastica, fatte da una risorsa rinnovabile, utilizzata per creare le penne BIC® Clic

BIC® Ecolutions™ Evolution® Classic / BIC® Ecolutions™ Evolution® Digital
BIC® Ecolutions™ Evolution® Colour Connection / BIC® Ecolutions™ Evolution® Digital Colour Connection

(ENG) Plastic is collected from homes, schools and businesses for recycling

(FRA) Plastique à recycler est collecté chez les particuliers, dans les écoles et les entreprises

(ESP) El plástico es recogido en casas, colegios y oficinas para su reciclado

(DEU) Der wiederverwertete Kunststoff stammt aus Haushalten, Schulen und Gewerbe

(ITA) Il plastico proviene dal riciclaggio di Case, scuole e uffici



(ENG) Plastic parts are flated, mixed and melted

(FRA) Les pièces en plastique sont alors aplaties, mélangées et fondues.

(ESP) Las piezas de plástico son troceadas, mezcladas y derretidas

(DEU) Der Kunststoff wird gepresst, vermisch und geschmolzen

(ITA) I componenti plastici sono mixati, lisciati e fusi

(ENG) The final result is pre-consumer recycled plastic pellets to make BIC® Ecolutions™ pencils

(FRA) Le résultat final est des granulés de plastique recyclés pré-consommateur destinés à destinés à fabriquer des crayons BIC® Ecolutions™

(ESP) El resultado final es un granulado de plástico reciclado pre-consumidor que se utiliza para fabricar lápices BIC® Ecolutions™

(DEU) Das Resultat ist pre-consumer (fabrikneues) Kunststoffgranulat zur Herstellung von BIC® Ecolutions™ Bleistifte

(ITA) Il risultato finale sono palline di plastica pre-utilizzate per ricreare nuove matite BIC® Ecolutions™

(ENG) Plastic parts are acquired from manufacturing facilities to be reused and not discarded

(FRA) Des pièces en plastique sont acquises auprès d'installations industrielles en vue d'être réutilisées au lieu d'être mises au rebut

(ESP) Las piezas de plástico son obtenidas de nuestro proceso de fabricación para ser reutilizadas y no desechadas

(DEU) Der Hersteller kauft wiederverwendbaren Kunststoff

(ITA) I componenti plastici sono acquistati da scarti produzione per essere riutilizzati



*** All BIC® Ecolutions™ Sticky Note Products are Available with Paper Stock Containing 100% Recycled Fiber and Water-based Adhesive**

The percentage is calculated based on paper stock



Paper is collected from homes, schools and businesses for recycling (1)



Paper is reduced to pulp and de-inked, then converted back into paper (2)

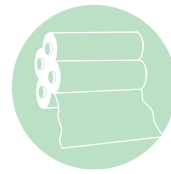

The final result is recycled paper used to make BIC® Sticky Note Ecolutions™ products (3)

(1) (FRA) Le papier à recycler est collecté chez les particuliers, dans les écoles et les entreprises / (ESP) El papel es recogido en casas, colegios y oficinas para su reciclado / (DEU) Das Recyclingpapier stammt aus Haushalten, Schulen und Gewerbe / (ITA) La carta proviene dal riciclaggio di Case, scuole e uffici. (2) (FRA) Le papier est désencré, réduit en pâte, puis retransformé en papier / (ESP) El papel es reducido a pulpa, se elimina la tinta y se vuelve a convertir en papel / (DEU) Das Recyclingpapier wird in Fasern aufgelöst, entfährt und wieder zu Papier verarbeitet / (ITA) La carta si riduce in pasta e viene tolto l'inchiostro dopodiché riconvertito in carta. (3) (FRA) Le papier recyclé est ensuite utilisé pour fabriquer des produits BIC® Sticky Note Ecolutions™ / (ESP) Como resultado final se obtiene papel de fibra reciclada, utilizado para producir productos BIC® Sticky Note / (DEU) Das Endergebnis ist Recyclingpapier, das zur Herstellung von BIC® Sticky Note Ecolutions™ Produkten verwendet wird / (ITA) Il risultato finale è carta riciclata e viene usato per fare i prodotti BIC® Sticky Note.



** Add the "Mobius loop" to your artwork at no additional charge! Next to the mobius loop, it is required to include the text "Recycled Paper". (Mobius loop imprint defaults to lower left hand corner of your notepad unless otherwise specified.).



Products available with recycled paper:

- 50mm x 75 mm Adhesive Notepads
- 68mm x 75mm Adhesive Notepads
- 75mm x 75mm Adhesive Notepads
- 101mm x 75mm Adhesive Notepads (Also with **NEW!** Alternating Sheet Imprint)
- **NEW!** 101mm x 101mm Adhesive Notepads
- 101mm x 152mm Adhesive Notepads
- 75mm x 75mm Adhesive Die Cut Notepads
- 101mm x 75mm Adhesive Die Cut Notepads

* Tous les produits BIC® Ecolutions™ Sticky Note sont disponibles en papier fabriqué avec des fibres 100% recyclées et d'adhésif à base d'eau. Le pourcentage de matériel recyclé est calculé sur le total de la bobine de papier

* Todos los productos BIC® Ecolutions™ Sticky Note están disponibles en papel 100% producido a partir de fibra reciclada y adhesivo a base de agua. El porcentaje de material reciclado está calculado sobre el total de la bobina de papel

* Alle BIC® Ecolutions™ Sticky Note Produkte werden aus 100% recycelten Fasern und mit einem Kleber auf Wasserbasis hergestellt. Der Prozentanteil wird auf Basis des Papierinhaltes berechnet.

* Tutti i nos BIC® Ecolutions™ Sticky Note sono disponibili con carta contenente 100% fibra riciclata e adesivo a base d'acqua. La percentuale di materiale riciclato e' calcolata sul totale della bobina di carta

See the BIC® Ecolutions™ Sticky Note section for product, code and order information

(FRA) Reportez-vous à la section BIC® Sticky Note pour plus d'informations sur les produits, et la procédure de commande / (ESP) Consulte la sección de BIC® Sticky Note para información de producto y pedidos / (DEU) Siehe BIC® Sticky Note für weitere Produkt und Bestellinformationen / (ITA) Vedi la sezione Sticky note per informazioni su prodotti ed ordini.

** (FRA) Nous proposons à nos clients l'option d'ajouter la « boucle de Möbius », sans frais supplémentaires. La mention « Papier recyclé » doit être accolée à la boucle de Möbius. (La boucle de Möbius sera placée, par défaut, en bas à gauche de la zone d'impression, sauf indication contraire.) / (ESP) Le ofrecemos a nuestros clientes la posibilidad de añadir el "Mobius loop" sin cargo. Al lado del "Mobius loop" se debe incluir el texto "Papel Reciclado". (El símbolo de reciclado se colocará en la parte inferior izquierda de la impresión, a menos que se indique lo contrario.) / (DEU) Wir bieten Ihnen die Möglichkeit, die Möbius Schleife ohne Aufpreis in Ihrem Design zu übernehmen. Der Text "Recyclingpapier" ist der Möbius Schleife hinzuzufügen. (Die Möbius-Schleife wird automatisch im unteren linken Bereich gedruckt, sofern nicht anders angegeben.) / (ITA) Offriamo ai nostri clienti la opzione di includere il mobius loop senza costi aggiuntivi. Vicino al logo "Mobius loop" è obbligatorio aggiungere il testo "Carta riciclata" (Il simbolo "Mobius loop" viene stampato automaticamente nell'angolo a sinistra dell'area di stampa, se non diversamente specificato.)





Combo

& Special
packaging





Combo Pack



BIC® Round Stic™
with BIC® 75mm x 75mm Adhesive Notepads



BIC® Media Clic
with BIC® 101mm x 75mm Adhesive Notepads

Combo Pack:

- Combine a writing instrument and a notepad
- Increase your communication impact

Combo Pack:

- Combinez un instrument d'écriture avec un bloc-notes
- Augmentez l'impact de votre communication

Combo Pack:

- Combine un instrumento de escritura y un block de notas adhesivas
- Aumente el impacto de su comunicación

Combo Pack:

- Kombinieren Sie Schreibgeräte und Notizblöcke
- Ihre Werbebotschaft zu maximieren!

Combo Pack:

- Combina una penna con un blocchetto
- Aumenta il tuo impatto comunicativo

Product Code

- 1 Product: **20001**
- 2 Products: **20002**
- 3 Products: **20003**

Code Produit

- 1 Produit: **20001**
- 2 Produits: **20002**
- 3 Produits: **20003**

Código de producto

- 1 Producto: **20001**
- 2 Productos: **20002**
- 3 Productos: **20003**

Produktcode

- 1 Produkt: **20001**
- 2 Produkte: **20002**
- 3 Produkte: **20003**

Codice prodotto

- 1 Prodotto: **20001**
- 2 Prodotti: **20002**
- 3 Prodotti: **20003**

Imprint

Due to different printing processes, the imprint colours pens and notepads may vary slightly.

Impression

Du fait des différents procédés d'impression, les couleurs de marquages peuvent différer légèrement

Impresión

Debido al uso de diferentes procesos de impresión, los colores de los bolígrafos y los blocks de notas pueden variar ligeramente.

Personalisierung

Aufgrund unterschiedlicher Drucktechniken, können die Druckfarben auf den Schreibgeräten und auf den Haftnotizen leicht abweichend sein.

Stampa

A causa delle differenti tecniche di stampa lo stesso colore stampato su penna e blocchetto potrebbe risultare diverso

Interested in more BIC® Combo Pack options? PLEASE CONTACT YOUR CUSTOMER SERVICE
 Intéressé par plus d'options avec le BIC® Combo Pack? N'HÉSITEZ PAS À CONTACTER VOTRE SERVICE CLIENT
 Interesado en más opciones de BIC® Combo Pack? POR FAVOR CONTACTE CON SU CUSTOMER SERVICE
 Haben Sie Interesse an weiteren BIC® Combo Pack Optionen? IHR ANSPRECHPARTNER IM INNENDIENST BERÄT SIE GERNE
 Sei interessato ad altre opzioni combo pack? CONTATTA IL TUO CUSTOMER SERVICE



pg 158

Please refer to the inside front cover for icon definitions.

Standard Packaging: All Combo Packs include cello wrap (pg 151)



Cello wrap



Frosted pouch for 1 or 2 items



*Media Pack

Cello wrap

Available for all BIC® writing instruments except Graphite pencils.

Code: **00057**

Cello wrap

Disponible pour tous les articles d'écriture BIC® sauf les crayons à papier.

Code: **00057**

Cello wrap

Disponibile para todos los instrumentos de escritura BIC® excepto lápices.

Código: **00057**

Cello wrap

Erhältlich für alle BIC® Schreibgeräte mit Ausnahme von Graphit-Bleistiften.

Code: **00057**

Cello wrap

Disponibile per tutti gli strumenti da scrittura BIC® eccetto matite (no portamine).

Codice: **00057**

Frosted pouch for 1 or 2 items

Available for 1 or 2 slim BIC® writing instruments except: Graphite pencils, BIC® Media Clic Grip and BIC® Matic Grip.

Code: **00051**

Pochette frost pour 1 ou 2 articles

Disponible pour 1 ou 2 articles d'écriture BIC® de corps fin sauf les crayons à papier, BIC® Media Clic Grip et BIC® Matic Grip.

Code: **00051**

Bolsa frosted para 1 ó 2 unidades

Disponibile para 1 ó 2 finos instrumentos de escritura BIC® excepto lápices, BIC® Media Clic Grip y BIC® Matic Grip.

Código: **00051**

Gefrostetes Kunststoffetui für 1 oder 2 Schreibgeräte

Erhältlich für 1 oder 2 schlanke BIC® Schreibgeräte mit Ausnahme von Graphit-Bleistiften, BIC® Media Clic Grip und BIC® Matic Grip

Code: **00051**

Astuccio frosted per 1 o 2 prodotti

Disponibile per 1 o 2 strumenti da scrittura sottili BIC® eccetto matite (no portamine), BIC® Media Clic Grip, e BIC® Matic Grip

Codice: **00051**

Media Pack

Developed for 2 BIC® Media Max or 3 BIC® Media Clic. Available for all BIC® writing instruments except Graphite Pencils.

Code: **00049** *While stock lasts

Media Pack

Développé pour 2 BIC® Media Max ou 3 BIC® Media Clic. Disponible pour tous les articles d'écriture BIC® sauf les crayons à papier.

Code: **00049** *Jusqu'à épuisement des stocks

Media Pack

Desarrollado para 2 BIC® Media Max ó 3 BIC® Media Clic. Disponible para todos los instrumentos de escritura BIC® excepto lápices.

Código: **00049** *Hasta fin de existencias

Media Pack

Für 2 BIC® Media Max oder 3 BIC® Media Clic geeignet. Erhältlich für alle BIC® Schreibgeräte mit Ausnahme von Graphit-Bleistiften.

Code: **00049** *Solange der Vorrat reicht

Media Pack

Appositamente studiato per 2 BIC® Media Max o 3 BIC® Media Clic. Disponibile per tutti i tipi di penna BIC® eccetto matite (no portamine).

Codice: **00049** *Fino ad esaurimento scorte



*Cardboard box 3 items



Black velvet pouch for 1 or 2 items



*Frosted wallet for 1, 2 or 3 items

Cardboard box 3 items
Available in black and white for all BIC® Graphite pencils.
Code: 40003 *While stock lasts

Etui cartonné 3 pièces
Disponible en blanc ou noir pour tous les crayons BIC®.
Code: 40003 *Jusqu'à épuisement des stocks

Estuche de cartón para 3 unidades
Disponible en blanco o negro para todos los lápices BIC®.
Código: 40003 *Hasta fin de existencias

Pappschachtel für 3 Bleistifte
Erhältlich in weiß und schwarz für alle BIC® Graphit-Bleistifte.
Code: 40003 *Solange der Vorrat reicht

Astuccio in cartone da 3 articoli
Disponibile in bianco e nero per tutte le matite (no portamine) BIC®.
Codice: 40003 *Fino ad esaurimento scorte

Black velvet pouch for 1 or 2 items
Available for all BIC® writing instruments except Graphite pencils.
Code: 00039, 00050

Pochette velours pour 1 ou 2 articles
Disponible pour tous les articles d'écriture BIC® sauf les crayons à papier.
Code: 00039, 00050

Funda de terciopelo negra para 1 ó 2 unidades
Disponible para todos los instrumentos de escritura BIC® excepto lápices.
Código: 00039, 00050

Schwarzes Samteti für 1 oder 2 Schreibgeräte
Erhältlich für alle BIC® Schreibgeräte mit Ausnahme von Graphit-Bleistiften.
Code: 00039, 00050

Astuccio in velluto nero per 1 o 2 prodotti
Disponibile per tutti gli strumenti da scrittura BIC® penna eccetto matite (no portamine).
Codice: 00039, 00050

Frosted wallet for 1, 2 or 3 items
Available for all BIC® writing instruments BIC® except BIC® Round Stic™ and Graphite pencils.
Code: 39001/2/3 *While stock lasts

Etui frost pour 1, 2 ou 3 articles
Disponible pour tous les articles d'écriture BIC® sauf le BIC® Round Stic™ et les crayons à papier.
Code: 39001/2/3 *Jusqu'à épuisement des stocks

Estuche frosted para 1, 2 ó 3 unidades
Disponible para todos los instrumentos de escritura BIC® excepto BIC® Round Stic™ y lápices.
Código: 39001/2/3 *Hasta fin de existencias

Geschenketui aus gefrostedem Kunststoff für 1, 2 oder 3 Schreibgeräte
Erhältlich für alle BIC® Schreibgeräte mit Ausnahme von BIC® Round Stic™ und Graphit-Bleistiften.
Code: 39001/2/3 *Solange der Vorrat reicht

Astuccio frosted per 1, 2 o 3 prodotti
Disponibile per tutti gli strumenti da scrittura BIC® eccetto BIC® Round Stic™ e matite (no portamine).
Codice: 39001/2/3 *Fino ad esaurimento scorte



*Painted Metal Gift Box for 1 or 2 items



Chrome Metal Gift Box for 1 or 2 items

Painted Metal Gift Box for 1 or 2 items

Available for: BIC® Attriant®, BIC® Wide Body® Metal, BIC® Wide Body® Metal Grip, BIC® Pivo® Metal, BIC® Steel™, BIC® Rubi, BIC® Slim Metal and BIC® Tri-Tone Twist.
Code: **38001, 38002** *While stock lasts

Boîte cadeau Métal peint pour 1 ou 2 articles

Disponible pour: BIC® Attriant®, BIC® Wide Body® Metal, BIC® Wide Body® Metal Grip, BIC® Pivo® Metal, BIC® Steel™, BIC® Rubi, BIC® Slim Metal et BIC® Tri-Tone Twist.
Code: **38001, 38002** *Jusqu'à épuisement des stocks

Estuche de regalo metal pintado para 1 ó 2 unidades

Disponible para: BIC® Attriant®, BIC® Wide Body® Metal, BIC® Wide Body® Metal Grip, BIC® Pivo® Metal, BIC® Steel™, BIC® Rubi, BIC® Slim Metal y BIC® Tri-Tone Twist.
Código: **38001, 38002** *Hasta fin de existencias

Schwarz lackiertes Metall-Geschenketui für 1 oder 2 Schreibgeräte

Erhältlich für: BIC® Attriant®, BIC® Wide Body® Metal, BIC® Wide Body® Metal Grip, BIC® Pivo® Metal, BIC® Steel™, BIC® Rubi, BIC® Slim Metal und BIC® Tri-Tone Twist.
Code: **38001, 38002** *Solange der Vorrat reicht

Astuccio regalo in Metallo Nero per 1 o 2 articoli

Disponibile per: BIC® Attriant®, BIC® Wide Body® Metal, BIC® Wide Body® Metal Grip, BIC® Pivo® Metal, BIC® Steel™, BIC® Rubi, BIC® Slim Metal e BIC® Tri-Tone Twist.
Codice: **38001, 38002** *Fino ad esaurimento scorte

Chrome Metal Gift Box for 1 or 2 items

Available for: BIC® Attriant®, BIC® Wide Body® Metal, BIC® Wide Body® Metal Grip, BIC® Pivo® Metal, BIC® Protrusion Grip, BIC® Steel™, BIC® Rubi, BIC® Slim Metal and BIC® Tri-Tone Twist.
Code: **00033, 00034**

Boîte cadeau Métal Chrome pour 1 ou 2 articles

Disponible pour: BIC® Attriant®, BIC® Wide Body® Metal, BIC® Wide Body® Metal Grip, BIC® Pivo® Metal, BIC® Protrusion Grip, BIC® Steel™, BIC® Rubi, BIC® Slim Metal et BIC® Tri-Tone Twist.
Code: **00033, 00034**

Estuche de regalo metal cromado para 1 ó 2 unidades

Disponible para: BIC® Attriant®, BIC® Wide Body® Metal, BIC® Wide Body® Metal Grip, BIC® Pivo® Metal, BIC® Protrusion Grip, BIC® Steel™, BIC® Rubi, BIC® Slim Metal y BIC® Tri-Tone Twist.
Código: **00033, 00034**

Metall-Geschenketui aus Chrom für 1 oder 2 Schreibgeräte

Erhältlich für: BIC® Attriant®, BIC® Wide Body® Metal, BIC® Wide Body® Metal Grip, BIC® Pivo® Metal, BIC® Protrusion Grip, BIC® Steel™, BIC® Rubi, BIC® Slim Metal und BIC® Tri-Tone Twist.
Code: **00033, 00034**

Astuccio regalo Metal Chrome per 1 o 2 articoli

Disponibile per: BIC® Attriant®, BIC® Wide Body® Metal, BIC® Wide Body® Metal Grip, BIC® Pivo® Metal, BIC® Protrusion Grip, BIC® Steel™, BIC® Rubi, BIC® Slim Metal e BIC® Tri-Tone Twist.
Codice: **00033, 00034**



Tube for 1 item



Black Velvet Pouch 1 or 2 items



*Gift Box for 1 or 2 items

Tube for 1 item

Available for: BIC® Attriant®, BIC® Wide Body® Metal family, BIC® Steel™, BIC® Rubi and BIC® Tri-Tone Twist.
Code: **36001**

Tube pour 1 article

Disponible pour: BIC® Attriant®, BIC® Wide Body® Metal family, BIC® Steel™, BIC® Rubi et BIC® Tri-Tone Twist.
Code: **36001**

Tubo para 1 unidad

Disponible para: BIC® Attriant®, BIC® Wide Body® Metal family, BIC® Steel™, BIC® Rubi y BIC® Tri-Tone Twist.
Código: **36001**

Tube Box für 1 Schreibgerät

Erhältlich für: BIC® Attriant®, BIC® Wide Body® Metal family, BIC® Steel™, BIC® Rubi und BIC® Tri-Tone Twist.
Code: **36001**

Tubo per 1 articolo

Disponibile per: BIC® Attriant®, BIC® Wide Body® Metal family, BIC® Steel™, BIC® Rubi e BIC® Tri-Tone Twist.
Codice: **36001**

Black Velvet Pouch 1 or 2 items

Available for all writing instruments, except graphite pencils.
Code: **00039, 00050**

Pochette velours noir pour 1 ou 2 articles

Disponible pour tous les articles d'écritures auf les crayons à papier.
Code: **00039, 00050**

Funda de terciopelo negra para 1 ó 2 unidades
Disponible para todos los productos de escritura excepto lápices.
Código: **00039, 00050**

Schwarzes Samteti für 1 oder 2 Schreibgeräte

Erhältlich für alle Schreibgeräte ausser Bleistifte.
Code: **00039, 00050**

Astuccio in velluto nero per 1 o 2 articoli

Disponibile per tutti gli strumenti da scrittura matite (no portamine) escluse.
Codice: **00039, 00050**

Gift Box for 1 or 2 items

Available for:
BIC® Pivo® Metal and BIC® Slim Metal.
Code: **32001, 32002** *While stock lasts

Boîte cadeau pour 1 ou 2 articles

Disponible pour:
BIC® Pivo® Metal et BIC® Slim Metal.
Code: **32001, 32002** *Jusqu'à épuisement des stocks

Estuche de regalo para 1 ó 2 unidades

Disponible para:
BIC® Pivo® Metal e BIC® Slim Metal.
Código: **32001, 32002** *Hasta fin de existencias

Geschenketui für 1 oder 2 Schreibgeräte

Erhältlich für:
BIC® Pivo® Metal und BIC® Slim Metal.
Code: **32001, 32002** *Solange der Vorrat reicht

Confezione regalo per 1 o 2 articoli

Disponibile per:
BIC® Pivo® Metal e BIC® Slim Metal.
Codice: **32001, 32002** *Fino ad esaurimento scorte



WW15

WW30

WW39/ WW50

Ellipse Gift Box

WW30

Available for Sheaffer® Prelude®, Sheaffer® Agio® and Sheaffer® 300. Optional for all other Sheaffer® writing instruments.

WW30

Disponible pour Sheaffer® Prelude®, Sheaffer® Agio® et Sheaffer® 300. En option pour tous les autres stylos Sheaffer®.

WW30

Disponible para Sheaffer® Prelude®, Sheaffer® Agio® y Sheaffer® 300. Opcional para el resto de instrumentos de escritura Sheaffer®.

WW30

Erhältlich für Sheaffer® Prelude®, Sheaffer® Agio® and Sheaffer® 300. Schreibgeräte. Optional für alle anderen Sheaffer® Schreibgeräte erhältlich.

WW30

Disponibile per Sheaffer® Prelude®, Sheaffer® Agio® and Sheaffer® 300. Opzionale per tutti gli altri prodotti Sheaffer®.

WW15

Available for Sheaffer® 100. Optional for Sheaffer® Sentinel®. Available for single products and sets.

WW15

Disponible pour Sheaffer® 100. En option pour Sheaffer® Sentinel®. Disponible pour produits seuls ou parures.

WW15

Disponible para para Sheaffer® 100. Opcional para Sheaffer® Sentinel®. Disponible para producto individual y sets.

WW15

Erhältlich für Sheaffer® 100 Schreibgeräte. Optional erhältlich für Sheaffer® Sentinel®. Für Einzelprodukte und Sets erhältlich.

WW15

Disponibile per Sheaffer® 100. Opzionale per Sheaffer® Sentinel®. Disponibile per singolo o set.

Ellipse Gift Box

Optional for Sheaffer® Sentinel®. Available for single products and sets.

Ellipse Gift Box

En option pour Sheaffer® Sentinel®. Disponible pour produits seuls ou parures.

Ellipse Gift Box

Opcional para Sheaffer® Sentinel®. Disponible para producto individual y sets.

Ellipse Gift Box

Optional erhältlich für Sheaffer® Sentinel®. Für Einzelprodukte und Sets erhältlich.

Ellipse Gift Box

Opzionale per Sheaffer® Sentinel® Schreibgeräte. Disponibile per singolo o set.

WW39/ WW50

Optional for Sheaffer® Sentinel®. Available WW39: suitable for single products WW50: suitable for sets

WW39/ WW50

En option pour Sheaffer® Sentinel® WW39: disponible pour produits seuls WW50: disponible pour parures.

WW39/ WW50

Opcional para Sheaffer® Sentinel® WW39: adecuado para uso individual WW50: adecuado para sets.

WW39/ WW50

Optional für Sheaffer® Sentinel® Schreibgeräte WW39: für Einzelprodukte WW50: für Sets.

WW39/ WW50

Opzionale per Sheaffer® Sentinel® WW39: adatto per prodotti singoli WW50: adatto per set.



General 
information



General Information

File information

File information

Required Files:

- Electronic file with the graphic design (artwork)
- Separate file for the text
For individual laser engraving please provide texts only in Excel format (.xls)

Artwork features:

Please send your artwork in one of the following formats:

- Jpg / 300 dpi not compressed (only for images, no texts)
- Pdf / outlined
- Illustrator CS4 / outlined
- Photoshop CS2 / with layers
- Zip files

In order to facilitate a fluid order process and obtain an appropriate final result, it is important to provide us the information in one of the above listed formats.

Minimum requirements for text and lines

Typefaces:

All the typefaces must be converted to an artwork. Verify the minimum type sizes & line weights:

Minimum type sizes:

- *image 1
- Laser engraving: 6 points
 - General: 7 points
 - Digital and Sticky Notes: 5 points
 - Notebooks. Debossing and Hot-stamping: font size 10 points and reverse font size 20 points

Minimum line weight:

- *image 2
- General: 0,5
 - Sticky Notes: 0,3
 - Notebooks (debossing and hot-stamping): 1,5
- For laser engraving we recommend the following standard typefaces:

*image 3: recommended type styles .

Half Tones:

- Not applicable in Laser Engraving
- We recommend 50% half tone

Informations concernant les fichiers

Fournir dans tous les cas:

- un fichier électronique avec le dessin graphique
- et un fichier différent pour le texte.
Pour un marquage au laser individuel, les textes devront être fournis uniquement sous format Excel (.xls).

Propriétés du matériel graphique:

Envoyez-nous votre matériel graphique dans un des types de fichiers suivants:

- Jpg / 300 dpi non compressé (seulement pour images sans texte)
- Pdf / vectorisé
- Illustrator CS4 / vectorisé
- Photoshop CS2 / avec les couches
- Zip fichiers

Il est important que vous nous fassiez parvenir l'information dans l'un de ces formats afin de traiter au mieux votre commande et obtenir un résultat final optimal.

Conditions minimum pour texte et lignes

Typographie:

Tout type de typographie doit être converti en matériel graphique. Vérifiez que la police d'écriture et l'épaisseur du tracé soient au minimum de:

Polices minimales:

- *image 1
- Marquage au laser: 6 points
 - Général: 7 points
 - Digital et Sticky Notes: 5 points
 - Notebooks, en embossage et estampage: 10 points et impressions en négatif 20 points

Épaisseur de ligne minimale:

- *image 2
- Général: 0.5
 - Sticky Notes: 0,3
 - Notebooks (en embossage et estampage): 1.5
- Pour le marquage au laser, nous recommandons les types de police d'écriture suivants:

*image 3: types de police recommandés

Demis tons:

- Non applicable sur la gravure laser
- Recommandé: demi ton à 50%

*image 1



*image 2

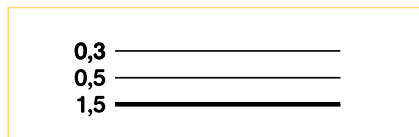

*image 3

• Fritz Quadrata 1234567890	• Benguiat 1234567890
• Garamond 1234567890	• Clarendon 1234567890
• Lucida 1234567890	• Palatino 1234567890
• ACaslon Regular 1234567890	• Berling Roman 1234567890
• AGaramond 1234567890	• Bodoni 1234567890
• Americana 1234567890	• Bookman 1234567890

Información sobre archivos

En cualquier caso, los archivos deben ser dos:

- un archivo electrónico con el diseño gráfico (creatividad)
- y otro archivo distinto para el texto.

Para un grabado en láser, facilite los textos únicamente en formato Excel. (.xls).

Propiedades del material gráfico:

Envíenos su material gráfico en alguno de los siguientes tipos de archivo:

- Jpg / 300 dpi sin comprimir (sólo imágenes, sin texto)
- Pdf / vectorizado
- Illustrator CS4 / vectorizado
- Photoshop CS2 / con capas
- Archivos zip

Es importante que nos proporcione la información en uno de estos formatos para agilizar su pedido y para obtener un resultado final adecuado.

Requisitos mínimos para texto y líneas

Tipografía:

Cualquier tipo de tipografía debe convertirse a gráfico. Compruebe que el cuerpo de letra y el grosor del trazo son como mínimo de:

Cuerpos de letra mínimos:

*image 1

- Grabado por láser: 6 puntos
- General: 7 puntos
- Digital y Sticky Notes: 5 puntos
- Notebooks, grabado en relieve y Hotstamping: 10 y 20 puntos para impresiones en negativo.

Grosor mínimo de línea:

*image 2

- General: 0,5
 - Sticky Notes: 0,3
 - Notebooks (grabado en relieve y Hotstamping): 1,5
- Para el grabado en láser recomendamos los siguientes tipos de letra estándar:

*image 3: tipografías estándar recomendadas

Trama:

- No aplicable en grabado en láser.
- Recomendamos el 50% de trama.

Druckvorlageanforderungen

Bitte senden Sie uns folgende Dateien:

- reprofähige Druckvorlagen als Grafik
- Textdatei.

Für personalisierte Lasergravuren müssen die Texte in Excel-Format (.xls) eingeschickt werden.

Technische Daten der Grafikdateien:

Bitte schicken Sie Ihre Grafiken in einem dieser Formate:

- Jpg / 300 dpi nicht komprimiert (nur Bilddateien, kein Text)
- Pdf / Vektordatei
- Illustrator CS4/Vektordatei
- Photoshop CS2 / mit Ebenen
- Zip format

Wir bitten um Zusendung der Daten in den angegebenen Formaten. Damit können wir den Auftrag schnellstmöglich bearbeiten und ein optimales Druckergebnis erreichen.

Mindestanforderung für Text und Linien

Schriftarten:

Alle Schriftarten müssen in Grafiken umgewandelt werden. Bitte beachten Sie die Mindestschriftgröße und -linienstärke:

Mindestschriftgröße:

*image 1

- Einzel Lasergravur: 6 punkt
- Allgemeine Gravur: 7 punkt
- Digital und Sticky Notes: 5punkt
- Notebooks: Mindestschriftgröße für Prägung und Hotstamping 10 Punkt und für Negativdrucke in 20 Punkt.

Linienstärke:

*image 2

- Allgemeine Gravur: 0,5
 - Sticky Notes: 0,3
 - Notebooks (Prägung & Hotstamping): 1,5
- Für Lasergravuren empfehlen wir die folgenden Standardschriftarten:

*image 3: Empfohlene Schriftarten

Rastertöne:

- Lasergravur nicht möglich
- Empfehlen einen 50% Rasterdruck

Informazione su file

Sempre, per quanto riguarda i file, i documenti si devono inviare come di seguito:

- un file elettronico con il design grafico (creatività)
- e un altro file separato per il testo.

Per un'incisione a laser singola, consegnare i testi esclusivamente in formato Excel (.xls).

Proprietà del materiale grafico:

Inviateci il vostro materiale grafico in uno dei seguenti tipi di file:

- Jpg / 300 dpi non compresso (solo immagini, senza testo)
- Pdf / vettorializzato
- Illustrator CS4 / vettorializzato
- Photoshop CS2 / con livelli
- Zip file

È importante che ci mandi la informazione in uno dei formati indicati al fine di agilizzare il suo ordine ed ottenere un miglior risultato finale.

Requisiti minimi per testo e linee

Tipografia:

Qualsiasi tipografia dovrà essere convertita in formato digitale.

Verifica che le dimensioni della tipografia e lo spessore del tratto siano come minimo di:

Dimensioni minime del font:

*image 1

- Incisione laser: 6 punti
- Serigrafia: 7 punti
- Digital e Sticky Notes: 5 punti
- Notebook: esclusivamente bassorilievo e stampa a caldo richiedono font 10 punti come minimo (negativo font 20 punti).

Spessore minimo della linea:

*image 2

- Serigrafia: 0,5
 - Sticky Notes: 0,3
 - Notebooks (bassorilievo e stampa a caldo): 1,5
- Per l'incisione laser consigliamo i seguenti caratteri standard:

*image 3: tipografia raccomandata

Retinatura:

- Non applicabile in caso di incisione laser
- Raccomandiamo il 50% della retinatura

Choose the right colour to print your artwork

Imprint colours

Choose the right colour to print your artwork

You have 3 options:

Match the trim colour

You can choose a print colour to match the trim (clip, cap and section) and barrel colours for many of our products. Simply request a "match trim" imprint colour.

Customized colour

Choose the colour you want (Pantone PMS C, HKS or RAL reference number). We cannot guarantee exact matches, especially when the imprint is made on a background colour other than white. Every effort will be made to match colours as closely as possible.

Stock colours

Choose one of our stock colours:

*image 4: stock colours

NOTEBOOKS.

Screen printing:

*image 5: stock colours

Additional stock metallic imprint colours:

Metallic Blue, Metallic Green, Metallic Red, Gold, Silver, Copper
Hot-stamping

*image 6: available colours

Proofs

Production proofs are recommended when colour matching is critical. An extra charge will be applied.

Couleurs d'impression

Choisissez la couleur appropriée pour l'impression de votre matériel graphique

Vous disposez de 3 options:

Assortissez la couleur des attributs

Pour la plupart de nos produits, vous pouvez assortir votre couleur d'impression à celle des attributs (clip, capuchon et section) et celles du corps. Spécifiez simplement sur votre commande "couleur d'impression assortie aux attributs".

Couleur personnalisée

Choisissez la couleur que vous préférez (Pantone PMS C, HKS ou numéro de référence RAL). Nous ne pouvons pas vous garantir une coïncidence totale, surtout dans les cas où l'impression est réalisée sur fond noir ou sur une autre couleur que le blanc. Quoi qu'il en soit, nous nous efforcerons d'obtenir la couleur qui se rapproche le plus de la couleur souhaitée.

Couleurs disponibles

*image 4: couleurs disponibles

Choisissez une couleur parmi nos couleurs disponibles:

NOTEBOOKS *.

Sérigraphie:

*image 5: couleurs disponibles

Autres couleurs métalliques disponibles :

Bleu métallique, vert métallique, rouge métallique, doré, argenté et cuivre.

Embossage et estampage

*image 6: couleurs disponibles

Échantillons

Nous vous conseillons de réaliser ces échantillons dans le cas où les combinaisons de couleurs seraient difficiles. Ce service implique un coût supplémentaire.

*image 4

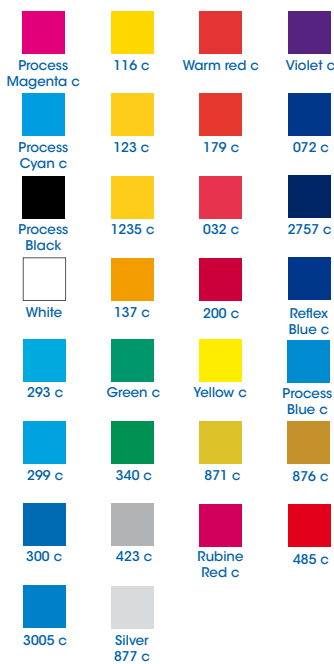

*image 5



*image 6

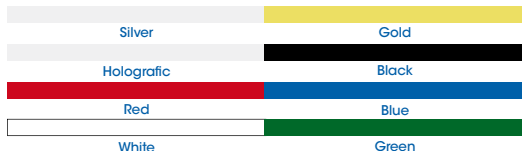

Colores de impresión

Elija el color adecuado para imprimir su diseño

Dispone de 3 opciones:

Igual que el color de los atributos

Para la mayoría de nuestros productos, puede optar por un color de impresión que coincida con el color de los atributos (clip, capuchón y sección) y con el color del cuerpo. Simplemente solicite un color de impresión que combine con estos atributos.

Color personalizado

Elija el color que prefiera (Pantone PMS C, HKS o número de referencia RAL). No podemos garantizarle una coincidencia exacta, sobre todo en aquellos casos en los que la impresión se realiza sobre fondo negro o sobre otro color distinto al blanco. En cualquier caso nos esforzaremos por lograr el color que más se acerque al solicitado.

Colores disponibles

Elija uno de nuestros colores disponibles:

*image 4: colores disponibles

NOTEBOOKS

Serigrafía:

*image 5: colores disponibles

Otros colores metálicos disponibles:

Azul metálico, verde metálico, rojo metálico, oro, plata y cobre.

Grabado en relieve y Hotstamping:

*image 6: colores disponibles

Muestras

Le recomendamos hacer muestras reales del producto en los casos en los que resulta difícil igualar el color. Este servicio conlleva un coste adicional.

Druckfarben

Wählen Sie die richtige Farbe für Ihr Design

Sie haben 3 Optionen:

Druckfarbe wie Ausstattungselemente

Der Werbeaufdruck ist für einen Großteil unserer Produkte in der gleichen Farbe wie die Ausstattungselemente möglich. Bestellen Sie einfach "Druckfarbe wie Ausstattungselemente".

Kundenspezifische Druckfarben

Geben Sie bitte die HKS, RAL oder PANTONE(R) Referenz an (PMS C). Wenn Sie nichts angeben, werden wir bei Schreibgeräten immer die C-Farbbreferenz und bei Sticky Notes die U-Farbbreferenz nehmen. Allerdings bemühen wir uns, die Farbvorgaben möglichst genau einzuhalten.

Standard-Druckfarben

Wählen Sie eine aus den beliebtesten und meist verwendeten Druckfarben!

*image 4: Standardfarben

NOTEBOOKS

Siebdruck:

*image 5: Erhältliche Farben

Weitere Standard-Metallicdruckfarben:

Metallic Blau, Metallic Grün, Metallic Rot, Gold, Silber, Kupfer

Hotstamping:

*image 6: Erhältliche Druckfarben

Korrekturausdrucke

Korrekturausdrucke sind empfehlenswert, wenn die Farbabstimmung Probleme aufweist. Für die Korrekturausdrucke wird ein Aufpreis berechnet.

Colori di stampa

Scegliete il colore adeguato per stampare il vostro logo

Sono disponibili 3 opzioni:

Lo stesso colore della decorazione

Per la maggior parte dei nostri prodotti potete optare per un colore di stampa che coincida con il colore dei particolari (clip, cappuccio e sezione) e con i colori del corpo. Richiedete semplicemente un colore che si abbinia a quello dei particolari.

Colore personalizzato

Scegliete il colore che preferite (Pantone PMS C, HKS o numero di riferimento RAL). Non possiamo garantirvi una coincidenza perfetta, soprattutto nei casi in cui la stampa si realizzi su sfondo nero o su un altro colore diverso dal bianco. Se non fosse identico sarà comunque il colore più vicino a quello richiesto.

Colori disponibili

Scegliete uno dei nostri colori disponibili:

*image 4: colori standard disponibili

NOTEBOOKS

Serigrafia:

*image 5: colori standard disponibili

Altri colori metallizzati disponibili:

Blu metallizzato, verde metallizzato, rosso metallizzato, oro, argento e rame.

Stampa a caldo

*image 6: colori standard disponibili

Campioni

Campioni reali sono raccomandati solo quando la grafica è particolarmente complessa.

La realizzazione dei campioni reali ha un costo aggiuntivo.

Surprising effects to enhance your brand

Special imprint options

Surprising effects to enhance your brand

Digital Transfer

An image is worth more than a thousand words. By means of a direct impression on the body of the lighter we are able to reproduce high resolution images. Ideal for reproducing photographs, logos and digital images. Minimum order: 300 units Available only for the J25 with white body

Metallic

Metallic inks... For more effect! Upgrade your message with metallic imprint inks at no extra charge. Three metallic colours available: blue, green and pink. Products available: On the barrel/body of: All writing instruments and lighters (except metal and soft barrels, graphite pencils).

Puffy

Makes your brand stand out! A highlighted personalisation with our "Puffy" ink. Fun puffy effect to feel your brand. Products available: On the barrel (only clip centered) of: BIC® Media Clic, BIC® Clic Stic™, BIC® Soft Feel®, BIC® Pivo®, BIC® Wide Body™ and BIC® Media Max. On the body (only 1 side) of: the whole lighter range.

Custom Made Colours

An "unlimited" choice of colours A completely personalised pen in any colour you want. Available for a large range of our best-sellers. An added-value service available in a reduced additional lead time.

Products available:

Barrel and trim of: BIC® Round Stic™, BIC® Media Clic, BIC® Media Clic Grip*, BIC® Clic Stic™, BIC® Pivo®, BIC® Media Max, BIC® Wide Body™, BIC® Soft Feel®.

*Grip available only in standard colour.

Minimum quantity: 10.000 units.

Options spéciales d'impression

Des effets surprenants qui font ressortir votre marque

Digital Transfer

Une image vaut mieux que mille mots. En imprimant directement sur le corps des briquets nous pouvons reproduire une image de haute résolution. Idéal pour reproduire des photographies, logos ou des images digitales. Quantité minimum par commande: 300 unités Disponible uniquement pour les briquets J25 avec le corps blanc Opaque.

Metallic

Encres métalliques... Pour un effet encore plus grand! Faites ressortir votre message avec une impression à l'encre métallique et sans aucun coût additionnel. Trois couleurs métalliques disponibles: bleu, vert et rose. Produits pour lesquels ce service est disponible: sur le corps de tous les instruments d'écriture et les briquets (à l'exception des corps en métal, des corps caoutchouc et des crayons).

Puffy

Faites en sorte que votre marque soit différente des autres! Une personnalisation attrayante grâce à notre encre Puffy. Créez un amusant effet Puffy pour votre marque. Produits pour lesquels ce service est disponible: sur le corps (centré sous le clip) du BIC® Media Clic, BIC® Clic Stic™, BIC® Soft Feel®, BIC® Pivo®, BIC® Wide Body™ et BIC® Media Max, ainsi que sur le corps (1 face) de tous les briquets.

Couleurs Personnalisées

Un choix illimité de couleurs Un stylo entièrement personnalisé aux couleurs de votre choix. Un service à valeur ajoutée disponible pour la plupart de nos best sellers et avec un temps de production additionnel réduit.

Produits disponibles:

Corps et attributs de: BIC® Round Stic™, BIC® Media Clic, BIC® Media Clic Grip*, BIC® Clic Stic™, BIC® Pivo®, BIC® Media Max, BIC® Wide Body™, BIC® Soft Feel®.

*Le grip est seulement disponible dans les couleurs standards.

Quantité minimum: 10.000 pièces.



Opciones especiales de impresión

Efectos sorprendentes que realzan su marca

Digital Transfer

Una imagen vale más que mil palabras.

Mediante una impresión directa en el cuerpo del encendedor podemos conseguir la reproducción de imágenes de alta resolución.

Ideal para reproducir fotografías, logos e imágenes digitales.

Pedido mínimo: 300 unidades.

Disponible sólo en J25 con cuerpo color blanco.

Metallic

Tintas metálicas... ¡Para un efecto todavía mayor!

Realce su mensaje imprimiendo con tinta metálica sin ningún coste adicional.

Tres colores metálicos disponibles: azul, verde y rosa.

Productos para los que está disponible:

En el atributo y cuerpo de: todos los instrumentos de escritura y encendedores (excepto en los cuerpos soft y metálicos y en los lápices de grafito).

Puffy

¡Haga que su marca se distinga del resto!

Una atractiva personalización gracias a nuestra tinta Puffy que da relieve. Cree un divertido efecto Puffy para su marca.

Productos para los que está disponible:

En el cuerpo (clip centrado) de: BIC® Media Clic, BIC® Clic Stic™, BIC® Soft Feel®, BIC® Pivo®, BIC® Wide Body™ y BIC® Media Max.

En el cuerpo (1 cara) de: la gama completa de encendedores.

Colores Personalizados

Una "ilimitada" elección de colores

Un bolígrafo completamente personalizado en el color que Vd. desee.

Disponible para una gran gama de nuestros productos más vendidos. Un servicio añadido en un tiempo de entrega reducido.

Productos disponibles:

Cuerpos y atributos de: BIC® Round Stic™, BIC® Media Clic, BIC® Media Clic Grip*, BIC® Clic Stic™, BIC® Pivo®, BIC® Media Max, BIC® Wide Body™, BIC® Soft Feel®.

*Grip sólo disponible en colores standard

Cantidad mínima: 10.000 unidades.

Besondere Druckoptionen

Überraschungseffekte mit optimaler Werbewirkung

Digital Transfer

Ein Bild sagt mehr als tausend Worte.

Hochaufgelöste Bilder können durch direkte Druckanbringung auf dem Feuerzeugschaft dargestellt werden.

Ideal für Photos, Logos und Digitalzeichnungen.

Mindestbestellmenge: 300 Stück.

Erhältlich nur auf opak weißem Schaft vom J25.

Metallic

Stärkere Wirkung mit Metallicfarben!

Erhöhen Sie mit Metallicfarben die Wirkung Ihrer Nachricht ohne jeglichen Aufpreis.

4 Metallicfarben erhältlich: blau, grün und pink.

Erhältliche Produkte: Auf Schaft/Körper von: Allen Schreibgeräten und Feuerzeugen (außer auf Metall- und gummierten Schaft und Bleistiften).

Puffy

So hebt sich Ihre Marke besonders ab!

Eine ganz besondere Darstellung Ihrer Marke mit unserer Puffy-Relieffinte.

Ihre Marke zum Erfühlen im Reliefeffekt.

Erhältliche Produkte:

Auf Schäften (in Verlängerung des Clips) von: BIC® Media Clic, BIC® Clic Stic™, BIC® Soft Feel®, BIC® Pivo®, BIC® Wide Body™ und BIC® Media Max.

Auf dem Körper (1 Seite) aller Feuerzeugmodelle.

Sondereinfärbungen

"Unbegrenzte" Möglichkeiten bei der Farbauswahl

Ein vollständig personalisierter Kugelschreiber in der Farbe Ihrer Wahl.

Erhältlich für eine breite Palette unserer Bestseller.

Eine hervorragende

Serviceleistung bei nur geringfügig längeren

Lieferzeiten.

Erhältlich für folgende Produkte:

Schaft und Ausstattungselemente von: BIC® Round Stic™, BIC® Media Clic, BIC® Media Clic Grip*, BIC® Clic Stic™, BIC® Pivo®, BIC® Media Max, BIC® Wide Body™, BIC® Soft Feel®.

*Grip nur in Standardfarben erhältlich

Standardfarben: 10.000 Stück.

Opzioni speciali di stampa

Effetti sorprendenti che mettono in risalto il vostro marchio

Digital Transfer

Un'immagine vale più di mille parole.

Grazie ad un'impressione digitale diretta sul corpo dell'accendino possiamo riprodurre un'immagine ad alta risoluzione.

Ideale per la riproduzione di fotografie, loghi ed immagini digitali.

Ordine minimo: 300 unità

Disponibile solo su corpo bianco del J25.

Metallic

Inchiostri metallizzati... Per un effetto ancora maggiore!

Mettete in risalto il vostro messaggio stampando con inchiostro metallizzato senza costi supplementari. Tre colori metallizzati disponibili:

blu, verde e rosa. Prodotti per i quali sono disponibili: tutti gli strumenti di scrittura e gli accendini (eccetto su penne morbide e metalliche e sulle matite di grafite).

Puffy

Rendete unico il vostro marchio!

Un'attraente personalizzazione grazie al nostro nuovo inchiostro Puffy. Create un divertente effetto Puffy per il vostro marchio. Prodotti per i quali è disponibile: BIC® Media Clic, BIC® Clic Stic™, BIC® Soft Feel®, BIC® Pivo®, BIC® Wide Body™ e BIC® Media Max. Tutta la gamma completa di accendini.

Colori Personalizzati

Una "ilimitata" scelta di colori

Una penna completamente personalizzata in qualsiasi colore tu voglia.

Disponibile per:

Corpo e particolari di: BIC® Round Stic™, BIC® Media Clic, BIC® Media Clic Grip*, BIC® Clic Stic™, BIC® Pivo®, BIC® Media Max, BIC® Wide Body™, BIC® Soft Feel®.

*Grip disponibile solo in colori standard

Quantità minima: 10.000 pezzi.

Do you need some advice on BIC® Sticky Note?



Do you need some advice on BIC® Sticky Note?

BIC® Sticky Note

Due to the nature of BIC® Sticky Note paper, resulting imprints will appear as matte, without shine. The reference colours chosen must be selected from the "PANTONE U" Guide. BIC® Sticky Note are printed using 4-colour process (CMYK), a technique which adjusts the imprint colour to match the references in the "PANTONE U" Guide. As such, the resulting imprint may differ slightly from the selected Pantone reference. If a direct Pantone is desired a fifth colour may be chosen from the "PANTONE U" Guide for an additional charge. For more information on achieving the closest colour match for imprints on different products within our catalogue please contact our Customer Service Department.

Imprinting area

Despite the fact that it's possible to print on the upper part of the pad (the adhesive area) we can only print up to 60% colour in this area.

Apart from the adhesive area, we recommend only printing 30% of the print area of the product to leave space for note taking and avoid poor ink absorption.

Bleeds

For BIC® Sticky note artworks, art intended to print to the edge must extend 1.5 mm outside the pad cut line on each side.

Flood coats

You can change the colour of one side of the paper on your BIC® Sticky Note by printing a flood coat over all or part of the surface. The recommended imprint colour percentage is about 10% depending on the colour. Light colours are best for writing on.

Shadow

Shadows or phantom imprints are available at no extra charge. Photographs, line drawings or large logos that cover most of the space at the centre look best.

As they are very light, text and phone numbers are not recommended as phantoms. The most appealing shades are about 10%.

Avez-vous besoin d'un conseil sur BIC® Sticky Note?

BIC® Sticky Note

En raison de la nature du papier BIC® Sticky Note, les résultats à l'impression auront un aspect mat, et non brillant. Les couleurs de référence choisies doivent être sélectionnées parmi le guide «PANTONE U». Les BIC® Sticky Note sont imprimés en quadrichromie (CMJN), une technique qui ajuste la couleur d'impression afin de correspondre aux références du guide «PANTONE U». À ce titre, le résultat à l'impression peut différer légèrement de la référence Pantone sélectionnée. Si vous souhaitez une couleur Pantone directe, une cinquième couleur en supplément peut être sélectionnée parmi le guide «PANTONE U». Pour plus d'informations sur la manière d'obtenir la couleur correspondante la plus proche pour des impressions sur différents produits de notre catalogue, veuillez contacter notre service client.

Zone d'impression

Même si la partie supérieure du bloc de papier peut être imprimée (la partie adhésive), elle peut seulement être imprimée jusqu'à 60% d'encre totale. Indépendamment de la zone adhésive, nous recommandons d'imprimer uniquement 30% de la surface du produit afin de laisser de l'espace pour la prise de notes et éviter d'éventuels problèmes d'adhésion de l'encre sur le papier.

Coupe dans les marges (Bleed)

Pour les fichiers graphiques des BIC® Sticky Note, en cas de coupe dans les marges, il est important de fournir une image agrandie de 1,5 mm de chaque côté.

Fond coloré ou fond perdu (Flood)

La couleur de la feuille de vos BIC® Sticky Note peut être changée en imprimant un fond coloré, dans sa totalité ou partiellement. Le pourcentage de trame de couleur conseillé est d'environ 10% selon la couleur choisie. Les couleurs claires sont recommandées.

Impression Shadow ou fantôme

Les impressions Shadow ou fantôme sont disponibles sans surcoût. Les photographies, les dessins ou logos de grande taille qui couvrent la majorité de la surface centrale ont un meilleur rendu. Comme ces impressions sont très claires, les textes et numéros de téléphone ne sont pas recommandés en Shadow ou fantôme. Les meilleurs rendus sont obtenus à partir d'images tramées aux environs de 10%.

¿Necesita algún consejo sobre las BIC® Sticky Note?

BIC® Sticky Note

Debido a la naturaleza del papel para BIC® Sticky Note el resultado impreso será mate, nunca brilla. Los colores de referencia solicitados deben ser de la Guía "PANTONE U". El proceso de impresión para BIC® Sticky Note es en cuatricromía (CMYK), y el resultado impreso puede variar de la referencia pantone solicitada.

Con la cuatricromía ajustamos el color a las referencias de la Guía "PANTONE U", en caso de querer un Pantone directo, podemos ofrecer la impresión con un 5º color de la Guía de "PANTONE U", esto conlleva un coste adicional. Para una mejor coincidencia de color entre los diferentes productos de nuestro catálogo, póngase en contacto con nuestro departamento de Atención al Cliente.

Área de impresión

A pesar de que la parte superior del taco de papel se puede imprimir (la parte adhesiva), sólo se puede imprimir hasta un 60% de tinta total. Aparte de la zona adhesiva, recomendamos imprimir únicamente el 30% de la zona correspondiente al taco de papel, a fin de dejar más espacio libre para tomar notas y evitar una absorción incorrecta de la tinta.

Diseños a sangre

Para los trabajos gráficos con BIC® Sticky Note, es importante que la impresión sobresalga 1,5 mm del paso de la línea de corte por todos los lados.

Color de fondo personalizado

Puede cambiar el color del papel de sus BIC® Sticky Note imprimiendo un color de fondo personalizado por toda o parte de la superficie de una de sus caras. Le recomendamos que el porcentaje de color de la estampación sea aproximadamente del 10%, en función del color elegido. Los colores suaves favorecen la escritura en la parte posterior.

Impresión "marca de agua"

Podemos ofrecerle "marcas de agua" sin coste adicional alguno. Las fotografías, los dibujos lineales o los logotipos de gran tamaño que cubren la mayor parte del espacio central son las opciones que ofrecen mejores resultados. Puesto que la impresión de "marcas de agua" es muy clara, no se recomienda para números de teléfono o texto. Las mejores "marcas de agua" son aquellas que se imprimen en torno al 10%.

Brauchen Sie Rat?

BIC® Sticky Note

Aufgrund der Papier- Beschaffenheit der BIC® Sticky Note, fällt das Druckergebnis matt aus. Die gewünschten Farbreferenzen wählen Sie aus der "PANTONE U" Farbpalette aus. BIC® Sticky Note werden im Offset-Druck nach Eurokala (CMYK) bedruckt. Dank dieser Technik wird das Farbergebnis an die gewünschten Pantone referenzen angenähert. Das Druckergebnis kann daher von der gewünschten PANTONE - Referenz abweichen. Es kann eine spezifische Pantone Farbe (Pantone U) als fünfte Farbe gedruckt werden. Hierfür wird ein Aufpreis berechnet. Weitere Informationen zur Farbleichung bei Bestellung von verschiedenen Produkten, erhalten Sie von Ihrem Customer Service.

Druckbereich

Obwohl es möglich ist auf dem oberen Bereich des BIC® Sticky Note zu drucken (der Teil des Haftbereichs) kann nur bis zu maximal 60% dieser Fläche bedruckt werden.

Außerhalb des Haftbereichs sollte maximal 30% der Fläche bedruckt werden, um möglichst viel Platz für Notizen frei zu lassen und das Ablösen des Druckes zu vermeiden.

Beschnitte

Bei BIC® Sticky Note Produkten müssen Grafiken, die bis zum Rand gehen, auf jeder Seite 1,5 mm über dem Beschnitttrand herausstehen.

Flood-Druck

Sie können die Vorderseite Ihrer BIC® Sticky Note einfärben lassen. Wir empfehlen abhängig von der Farbe einen Farbdruck von etwa 10% igen Farbdruck. Helle Farben eignen sich am besten um die Schrift klar sichtbar zu machen.

Shadow-Druck

Flood- und Shadowdruckeffekte sind ohne Aufpreis erhältlich. Fotos, Zeichnungen oder große Logos, die einen Großteil der Grundfläche bedecken, eignen sich dafür am besten. Texte und Telefonnummer sind für Hintergrunddrucke nicht geeignet, da sie zu schwer zu erkennen sind. Beste Resultate werden mit 10% Rasterung erzielt.

Avete bisogno di consigli sulle note adhesive?

BIC® Sticky Note

Dovuto alla natura della carta, per lo BIC® Sticky Note il risultato di stampa sarà opaco, mai brillante. I colori di riferimento richiesti dovranno provenire dalla guida "Pantone U". Il processo di stampa degli BIC® Sticky Note è in quadricromia (CMYK) ed il risultato può variare rispetto al colore di riferimento richiesto.

Con la quadricromia consideriamo il pantone U come riferimento, in caso si volesse un Pantone diretto, possiamo offrire una stampa con un 5º colore della guida Pantone U, il quale avrà un costo aggiuntivo.

Per maggiori informazioni riguardo ai colori dei prodotti nel nostro catalogo, contattare con il nostro ufficio Assistenza al Cliente.

Area di stampa

Anche se la parte superiore del blocchetto si può stampare (la parte adesiva) si raccomanda di non optare in quest'area per una stampa a tutto colore. A parte la zona adesiva, si raccomanda stampare unicamente il 30% della superficie del prodotto, per lasciare più spazio libero per prendere appunti ed evitare un assorbimento scorretto dell'inchiostro.

Taglio al vivo

Per i lavori grafici con BIC® Sticky Note è importante che la stampa fuoriesca di 1,5 mm dal passaggio della linea di taglio su entrambi i lati.

Sfondo

Potete modificare il colore della carta dei vostri BIC® Sticky Note stampando uno sfondo totale o parziale della superficie, su una sola facciata. Vi consigliamo una percentuale di colore di stampa di circa il 10%, a seconda del colore scelto. I colori tenui favoriscono la successiva scrittura.

Ombreggiature

Possiamo stampare ombreggiature o sfumature senza costi supplementari. Le fotografie, i disegni lineari o i logotipi di grandi dimensioni che coprono la maggior parte dello spazio centrale sono le opzioni che danno i migliori risultati. Dal momento che le stampe ombreggiate sono molto chiare, non sono consigliabili per numeri di telefono o testo. Le ombre migliori sono quelle che si stampano intorno al 10%.



General Information Sheaffer®

Sheaffer® Limited 1-Year Warranty

For a period of one year from the date of purchase, Sheaffer will repair or replace, at its option, this writing instrument, free of charge, if it has a mechanical failure due to defect in material or workmanship. This warranty does not cover loss, accidental damage, reasonable wear and tear, misuse, or abuse such as improper use and care. This warranty gives you specific legal rights. You may also have other rights that may vary from country to country. Applies to Sheaffer Sentinel, Sheaffer 100 and Sheaffer 300.

Sheaffer® Limited 3-Year Warranty

These Sheaffer® writing instruments are warranted against mechanical failure due to defects in material or workmanship for a period of three (3) years from the date of purchase from an authorized Sheaffer Retailer. Should such mechanical failure occur, please return the complete writing instrument with proof of original purchase to an authorized Sheaffer Service Center and Sheaffer will repair the writing instrument. If a repair is not possible in a reasonable period of time, Sheaffer will exchange the writing instrument for one of comparable value. This three (3) year warranty is only valid with proof of original purchase and does not cover loss, accidental damage, misuse, reasonable wear and tear, or abuse such as improper use and care. This warranty may be transferred. Sheaffer is not responsible for lost or misdirected mail. This warranty gives you specific legal rights. You may have other rights which may vary from country to country. Applies to Sheaffer Agio.

Sheaffer® Limited Lifetime Warranty

These Sheaffer® writing instruments are guaranteed against mechanical failure due to original factory defects in materials and workmanship, for the lifetime of its first owner. Should such failure occur, please return the complete instrument to the nearest authorized Sheaffer Service Retailer with proof of first ownership. It will be repaired or exchanged for one of comparable value, free of charge. Please visit www.sheaffer.com for additional information. This warranty does not cover loss, accidental damage, misuse or abuse. This warranty gives you specific legal rights. You may also have other rights, which vary from country to country. Applies to Sheaffer Legacy and Sheaffer Prelude.

Garantie Sheaffer® limitée à 1 an

Pendant une période d'un an à compter de la date d'achat, Sheaffer répare et remplace, à sa discrétion, cet instrument d'écriture, sans frais, en cas de défaillance mécanique à la suite de défauts et de malfaçon. Cette garantie ne couvre pas la perte, les dégâts accidentels, l'usure raisonnable, l'usage inapproprié ou les abus tels que le manque de considération et de soin. Cette garantie vous procure des droits légaux particuliers. Vous pouvez également disposer d'autres droits, qui peuvent varier d'un pays à l'autre. S'applique à Sheaffer Sentinel, Sheaffer 100 et Sheaffer 300.

Garantie Sheaffer® limitée à 3 ans

Ces instruments d'écriture Sheaffer® sont garantis contre la défaillance mécanique à la suite de défauts et de malfaçon, pendant une période de trois (3) ans à compter de la date d'achat auprès d'un distributeur agréé Sheaffer. En cas de défaillance mécanique, veuillez renvoyer l'instrument complet avec la preuve d'achat original à un distributeur Sheaffer agréé et Sheaffer réparera l'instrument d'écriture. Si la réparation n'est pas possible dans un délai raisonnable, Sheaffer échangera l'instrument d'écriture par un instrument de valeur comparable. Cette garantie de trois (3) ans est uniquement valable si elle est accompagnée de la preuve de l'achat original et ne couvre pas la perte, les dégâts accidentels, le mauvais usage, l'usure raisonnable ou les abus tels que le manque de considération et de soin. Cette garantie peut être cédée. Sheaffer décline toute responsabilité en cas de perte ou de mauvaise utilisation du courrier. Cette garantie vous procure des droits légaux particuliers. Vous pouvez également disposer d'autres droits, qui peuvent varier d'un pays à l'autre. S'applique à Sheaffer Agio.

Garantie limitée Sheaffer® à vie

Ces instruments d'écriture Sheaffer® sont garantis contre la défaillance mécanique à la suite de défauts d'usine des matériaux et de malfaçon, pendant toute la durée d'usage de son premier propriétaire. En cas de défaillance, veuillez renvoyer l'instrument complet au distributeur Sheaffer agréé le plus proche, avec la preuve de premier propriétaire. Il sera réparé ou échangé par un instrument de la même valeur, sans frais. Veuillez visiter www.sheaffer.com pour plus d'informations. Cette garantie ne couvre pas la perte, les dégâts accidentels, l'utilisation inappropriée ou excessive. Cette garantie vous procure des droits légaux particuliers. Vous pouvez également disposer d'autres droits, qui peuvent varier d'un pays à l'autre. S'applique à Sheaffer Legacy et Sheaffer Prelude.

Garantía limitada de 1 año Sheaffer®

Durante un periodo de un año desde la fecha de compra, Sheaffer reparará o sustituirá, según lo crea conveniente, este instrumento de escritura de forma gratuita si tiene un fallo mecánico debido a defectos de material o factura. Esta garantía no cubre la pérdida, daños accidentales, uso y desgaste razonable, mal uso o uso negligente, como uso y cuidado inadecuado. Esta garantía le proporciona derechos legales específicos. Puede que tenga otros derechos que pueden variar en distintos países. Es aplicable a Sheaffer Sentinel, Sheaffer 100 y Sheaffer 300.

Garantía limitada de 3 años Sheaffer®

Estos instrumentos de escritura Sheaffer® están garantizados contra fallos mecánicos debidos a defectos de material o montaje durante un periodo de tres (3) años desde la fecha de compra en una tienda Sheaffer autorizada. En caso de que se produzca un fallo mecánico así, devuelva el instrumento de escritura completo con un comprobante de la compra original a un Centro de servicio al cliente Sheaffer y Sheaffer le reparará el instrumento de escritura. Si no se puede llevar a cabo una reparación en un periodo de tiempo razonable, Sheaffer sustituirá el instrumento de escritura por uno de un valor equivalente. Esta garantía de tres (3) años solo será válida con un comprobante de la compra original y no cubre la pérdida, daños accidentales, uso y desgaste razonable, mal uso o uso negligente, como uso y cuidado inadecuado. Esta garantía se podrá transferir. Sheaffer no es responsable de pérdida o de que se envíe a una dirección equivocada. Esta garantía le proporciona derechos legales específicos. Puede que tenga otros derechos que pueden variar en distintos países. Es aplicable a Sheaffer Agio.

Garantía limitada de por vida Sheaffer®

Estos instrumentos de escritura Sheaffer® están garantizados contra fallos mecánicos debido a defectos de fábrica originales de material o factura durante toda la vida de su primer propietario. En caso de que se produjera un fallo, devuelva el instrumento completo a un servicio de asistencia autorizado de Sheaffer más cercano con un comprobante de primera propiedad. Se reparará o sustituirá por uno de valor equivalente, de forma gratuita. Visite www.sheaffer.com para información adicional. Esta garantía no cubre pérdida, daños accidentales, mal uso o uso negligente. Esta garantía le proporciona derechos legales específicos. Puede que tenga otros derechos que pueden variar en distintos países. Es aplicable a Sheaffer Legacy y Sheaffer Prelude.

Sheaffer® Eingeschränkte 1-Jahres-Garantie

Für einen Zeitraum von einem Jahr ab dem Kaufdatum wird Sheaffer nach eigener Wahl dieses Schreibgerät kostenlos reparieren oder ersetzen, falls infolge eines Material- oder Verarbeitungsdefektes ein mechanisches Versagen eintritt. Diese Gewährleistung gilt nicht bei Verlust, unbeabsichtigter Beschädigung, zumutbarer Abnutzung, Zweckentfremdung oder Missbrauch, wie z.B. bei unsachgemäßer Nutzung und Pflege. Diese Gewährleistung gibt Ihnen spezifische gesetzliche Rechte. Sie könnten auch andere Rechte genießen, die von Land zu Land unterschiedlich sein könnten. Diese Garantie gilt für den Sheaffer Sentinel, Sheaffer 100 und Sheaffer 300.

Sheaffer® Eingeschränkte 3-Jahres-Garantie

Im Falle eines mechanischen Versagens infolge von Material- oder Verarbeitungsdefekten unterliegen diese Sheaffer®-Schreibgeräte für einen Zeitraum von drei (3) Jahren ab dem Datum des Kaufes bei einem autorisierten Sheaffer-Einzelhändler dieser Garantie. Sollte ein solches mechanisches Versagen eintreten, schicken Sie das vollständige Schreibgerät bitte zusammen mit dem Beleg des ursprünglichen Kaufes an ein autorisiertes Sheaffer-Kundendienstzentrum zurück und Sheaffer wird das Schreibgerät reparieren. Falls es innerhalb eines angemessenen Zeitraums nicht möglich sein sollte, die Reparatur vorzunehmen, wird Sheaffer das Schreibgerät gegen eines von vergleichbarem Wert austauschen. Diese dreijährige (3 Jahre) Garantie gilt nur unter Vorlage des Originalkaufbelegs und gilt nicht bei Verlust, unbeabsichtigter Beschädigung, Zweckentfremdung, zumutbarer Abnutzung oder Missbrauch, wie z.B. bei unsachgemäßer Nutzung und Pflege. Diese Garantie ist übertragbar. Sheaffer übernimmt keine Verantwortung für verlorengegangene oder fehlgeleitete Postsendungen. Diese Gewährleistung gibt Ihnen spezifische gesetzliche Rechte. Sie könnten auch andere Rechte genießen, die von Land zu Land unterschiedlich sein könnten. Diese Garantie gilt für den Sheaffer Agio.

Sheaffer® Eingeschränkte Garantie auf Lebenszeit

Im Falle eines mechanischen Versagens infolge von ursprünglichen Fabrikdefekten in den Materialien und der Verarbeitung unterliegen diese Sheaffer®-Schreibgeräte für die gesamte Lebensdauer ihres ersten Besitzers dieser Garantie. Sollte ein derartiges Versagen eintreten, schicken Sie das vollständige Instrument bitte zusammen mit dem Nachweis des ersten Besitzes an den nächstgelegenen autorisierten Sheaffer-Servicehändler zurück. Es wird kostenlos repariert oder gegen eines von vergleichbarem Wert ausgetauscht. Für zusätzliche Informationen besuchen Sie bitte www.sheaffer.com. Diese Gewährleistung gilt nicht bei Verlust, unbeabsichtigter Beschädigung, Zweckentfremdung oder Missbrauch. Diese Gewährleistung gibt Ihnen spezifische gesetzliche Rechte. Sie könnten auch andere Rechte genießen, die von Land zu Land unterschiedlich sein könnten. Diese Garantie gilt für den Sheaffer Legacy und Sheaffer Prelude.

Garanzia limitata di 1 anno Sheaffer®

Per un periodo di un anno dalla data di acquisto, Sheaffer riparerà o sostituirà gratuitamente, a sua discrezione, questo strumento di scrittura, in caso di guasti meccanici dovuti a un difetto materiale o di lavorazione. La presente garanzia non copre perdite, danni accidentali, normale deterioramento, uso improprio o uso illecito, come uso inidoneo e manutenzione impropria. Questa garanzia fornisce diritti legali specifici e anche altri diritti, a seconda dei vari paesi. La presente garanzia si applica a Sheaffer Sentinel, Sheaffer 100 e Sheaffer 300.

Garanzia limitata di 3 anni Sheaffer®

Questi strumenti di scrittura Sheaffer® sono garantiti da guasti meccanici dovuti a difetti materiali o di lavorazione per un periodo di tre (3) anni dalla data di acquisto presso un Rivenditore Sheaffer autorizzato. Nel caso si verificasse un simile guasto, riportare lo strumento di scrittura completo corredato dalla prova di acquisto originale a un Centro assistenza autorizzato Sheaffer e Sheaffer provvederà a ripararlo. Se non è possibile eseguire una riparazione in tempi ragionevolmente brevi, Sheaffer sostituirà lo strumento di scrittura con uno di valore equivalente. Questa garanzia di tre (3) anni è valida soltanto se esibita congiuntamente alla prova di acquisto originale e non copre perdite, danni accidentali, uso improprio, normale deterioramento, o uso illecito, come uso inidoneo e manutenzione impropria. Questa garanzia è trasferibile. Sheaffer non è responsabile di perdite o di inoltro errato del prodotto via posta. La presente garanzia fornisce diritti legali specifici e anche altri diritti, che variano di paese in paese. Si applica a Sheaffer Agio.

Garanzia limitata a vita Sheaffer®

Questi strumenti di scrittura Sheaffer® sono garantiti da guasti meccanici dovuti a difetti di fabbrica nei materiali e nella lavorazione per tutta la vita dalla data di acquisto. Nel caso si verificasse un simile guasto, riportare lo strumento completo al Centro assistenza autorizzato più vicino, corredato dalla prova di acquisto originale. Il prodotto sarà gratuitamente riparato o sostituito con uno di valore equivalente. Per maggiori informazioni visitare il sito www.sheaffer.com. Questa garanzia non copre perdite, danni accidentali, uso improprio o uso illecito. Questa garanzia fornisce diritti legali specifici. E anche altri diritti, che variano a seconda dei vari paesi. Si applica a Sheaffer Legacy e Sheaffer Prelude.

Service de production 48 heures GRATUIT!

Avec BIC Graphic, être livré en temps record, **C'EST PLUS FACILE QUE JAMAIS!**
Disponible pour les instruments d'écriture, Sticky Note, Briquets, Coques et Notebooks.

Merci de vous référer au logo service de production  48 heures sur les pages produits.

Conditions requises

Méthodes de Personnalisation disponibles

Writing instruments

1 couleur d'impression sur le corps
(gravure laser disponible seulement sur les produits metals)

Sticky note

Impression en quadrichromie (25 et 50 feuilles)

Lighters

1 couleur d'impression

Cases

1 couleur d'impression

Notebooks

1 couleur d'impression
(Sérigraphie disponible sur le BIC® Notebooks Plastic Cover)
Impression quadrichromie (disponible sur BIC® Chipboard Cover 4-Colours)

Position d'impression

1 position standard

Quantité Maximum

Dernière colonne de la liste de prix
Sticky Note Mini et Medium disponibles jusqu'à 1.000 unités
Notebooks disponibles jusqu'à 250 unités

Commande et référence E-mail

48H doit être inclus dans le sujet de l'email
Pour les commandes saisies sur le magasin en ligne: 48H doit être inclus dans le mot-clé

Pays Eligibles

Union Européenne, Suisse and Norvège

Code Promotion

48 H - DOIT être indiqué en cas de commande

Information complémentaire:

Dans le cas où le produit commandé serait sans-stock, nous vous proposerons une alternative

Les conditions pour la commande

- La commande complète et la fiche de marquage doivent être reçus par BIC Graphic Europe avant 12:00 p.m. GMT+1, du Lundi au Vendredi. Les fiches de marquage qui requièrent l'accord du client doivent être validées avant 2:00 p.m. GMT+1.
- Les Week-ends et les jours fériés de l'Espagne ne sont pas considérés comme des jours ouvrés.

Livraison

- BIC ne peut pas garantir de date de livraison

Autres

- Les crayons BIC® sont seulement disponibles en bout coupé et sans pointe.
- Modification de la fiche de marquage - Merci de rajouter un délai supplémentaire en cas de modification du marquage.
- Les comptes bloqués par la finance ne sont pas éligibles.
- BIC ne peut pas garantir le Service Fabrication en 48 Heures en cas de tout élément extérieur que BIC ne pourrait raisonnablement contrôler.

www.bicgraphic.com



¡Servicio de producción 48 horas GRATIS!

¡Con BIC Graphic es más fácil que nunca **RECIBIR SU PEDIDO YA!**
Disponible en Writing Instruments, Sticky Note, Lighters, Cases y Notebooks.

Busque el icono de servicio de producción  48 horas en las páginas de producto

Condiciones del Programa

Técnicas de Impresión

Writing instruments

1 color de impresión en el cuerpo
(Impresión a láser sólo disponible en productos de metal)

Sticky note

Impresión en cuatricromía (25 y 50 hojas)

Lighters

1 color de impresión

Cases

1 color de impresión

Notebooks

1 color de impresión (Serigrafía disponible en BIC® Notebooks Plastic Cover)
Digital (Disponible en la libreta BIC® Chipboard Cover 4-Colours)

Área de Impresión

1 Posición (ver opciones en catálogo)

Cantidad Máxima

Última columna de la Lista de Precios
Sticky Note Mini y Medium disponibles hasta 1.000 unidades
Notebooks disponibles hasta 250 unidades

E-mail con Pedido y Arte Final

Se debe incluir en el asunto del e-mail: 48 horas.
Para pedidos online: se debe incluir 48 horas en la palabra clave

Países Incluidos

Unión Europea, Suiza y Noruega

Código de Promoción

Indicar en el pedido la referencia "48 horas"

Detalles Adicionales del Programa:

En el caso de no disponer de stock para el producto solicitado, le ofreceremos un producto alternativo

Otros Requisitos

- El pedido y el arte final deben ser recibidos por BIC Graphic Europe antes de las 12:00 p.m. GMT+1, de lunes a viernes. Los pedidos que requieran aprobación por parte del cliente, deben ser aprobados antes de las 2:00 p.m. GMT+1.
- Fines de semana y festividades locales en España no serán considerados como días laborables.

Envíos

- BIC no puede garantizar el día de entrega.

Otros

- Los lápices BIC® están solo disponibles con los extremos cortados y sin punta.
- En caso de modificaciones en el arte final no se podrán respetar las 48 h. de producción que ofrece el programa.
- Aquellos pedidos realizados por cuentas con facturas pendientes no serán aceptados en el programa 48 h. (Los pedidos con facturas pendientes de pago no serán aceptados dentro del programa).
- BIC no garantiza el servicio de producción en 48 h. por causas ajenas a la empresa.

www.bicgraphic.com



NEU! GRATIS 48 Stunden Produktionszeit!

BIC Graphic macht's möglich –ERHALTEN SIE IHRE WARE SOFORT!

Gültig für Schreibgeräte, Sticky Notes, Feuerzeuge (inkl. Hüllen) und Notebooks.

Achten Sie auf das „48-Stunden“ Symbol  auf den Produktseiten

Aktionsbedingungen

Erhältliche Personalisierungsoptionen

Schreibgeräte

1-farbiger Druck auf dem Schaff
(Lasergravur nur auf Metall-Schreibgeräten)

Sticky note

Vierfarbdruck (25 und 50 Blatt)

Feuerzeuge

1-farbiger Druck

Feuerzeughüllen

1-farbiger Druck

Notebooks

1-farbiger Druck (Siebdruck auf BIC® Notebooks mit Kunststoff-Deckblatt)
Vierfarbdruck (auf 4-Colours BIC® Notebooks mit Karton-Deckblatt)

Druckposition

1 Standardposition

Höchstbestellmenge

Letzte Staffel in der Preisliste
Sticky Note Mini und Medium bis max. 1.000 Stück
Notebooks bis max. 250 Stück

eMail Bestellung und Druckvorlage

48H muß in der Betreffzeile angegeben werden
Bei Online-Bestellungen: 48H muß im Keyword-Feld angegeben werden

Gültig in folgenden Ländern

Europäische Union, Schweiz und Norwegen

Promotionscode

48H MUSS bei Bestellung angegeben werden

Weitere Aktionsinformation

Sollte das bestellte Produkt nicht lagernd sein, bieten wir Ihnen ein Alternativprodukt an

Bestellanforderungen

- Vollständige Bestellung sowie Druckvorlage / Gut zum Druck müssen bei BIC Graphic Europe bis spätestens 12.00 Uhr GMT+1, montags bis freitags, eintreffen. Druckvorlagen müssen bis spätestens 14.00 Uhr GMT+1 freigegeben werden.
- Wochenenden und spanische Feiertage zählen nicht als Werktage.

Transport

- BIC kann kein Lieferdatum garantieren.

Sonstiges

- BIC® Bleistift nur ohne Radiergummi und ungespitzt erhältlich.
- Bei Änderungen der Druckvorlage wird die Produktionszeit dementsprechend angepaßt.
- Nicht gültig für Aufträge mit Vorauskasse.
- BIC garantiert eine Produktionszeit von 48 Stunden, hiervon ausgeschlossen sind Einwirkungen verursacht durch höhere Gewalt.

www.bicgraphic.com



Servizio di produzione 48 ore GRATIS!

Con BIC Graphic è piu` facile che mai RICEVERE IL TUO ORDINE!

Disponibile per Strumenti da scrittura, Sticky Note, Accendini, Porta accendini e Notebooks.

Cerca la icona del servizio 48 ore di produzione  nelle pagine dei prodotti

Condizioni del programma

Disponibile per le seguenti tecniche di stampa

Writing instruments

Stampa ad 1 colore sul corpo
(Incisione Laser solo su prodotti di metallo)

Sticky note

Stampa in quadricromia (25 e 50 fogli)

Lighters

Stampa ad 1 colore

Cases

Stampa ad 1 colore

Notebooks

Stampa ad 1 colore (Serigrafia disponibile per BIC® Notebook Plastic Cover)
Stampa in quadricromia (disponibile per BIC® Chipboard Cover 4-Cover)

Posizione di stampa

1 posizione standard

Quantità massima

Ultima colonna del listino prezzi
Sticky Note Mini e Medium disponibile solo fino a 1.000 pezzi
Notebooks disponibile fino a 250 pezzi

Ordini per email e Arte finale

La dicitura 48H deve essere riportata nell'oggetto della mail di ordine
In caso di ordine per email: si deve sempre includere *48H* nel Keyword.

Paesi inclusi

Unione Europea, Svizzera e Norvegia

Codice promozione

48H deve essere chiaramente riportato nell'ordine

Informazioni aggiuntive:

Nel caso fossimo sprovvisti di stock per i prodotti ordinati, sarà nostra premura fornire un prodotto in alternativa.

Requisiti per l'ordine

- Gli ordini completi in formato elettronico, incluso l'artwork definitivo, devono essere ricevuti da BIC Graphic Europe entro le ore 12.00 pm GMT+1. Per tutti gli ordini che richiedono l'approvazione della bozza di stampa, la stessa deve pervenire entro le ore 14.00
- I fine settimana e le festività locali spagnole non sono considerati come giorni lavorativi.

Spedizioni

- BIC non può garantire l'esatta data di consegna.

Inoltre

- Le matite BIC® sono disponibili solo senza gomma e punta.
- Modifiche dell' artwork - ti preghiamo di considerare il tempo necessario per apportare le eventuali modifiche. In questo caso il termine dell' 48 ore non sarà rispettato
- La promozione non viene applicata a clienti con credito bloccato
- BIC non garantisce il servizio di produzione in 48 ore per cause non imputabili all'azienda e pertanto fuori dal proprio controllo.

www.bicgraphic.com



Product Index

Writing Instruments

Product Name	Page
BIC® Style	14
BIC® Style Clear	15
BIC® Round Stic™	16
BIC® XS Finestyle & XS Clear Finestyle	17
BIC® Media Clic	18
BIC® Media Clic Grip	19
BIC® Media Clic Grip Digital	20
BIC® Media Clic Premium	21
BIC® Clic Stic™	22
BIC® Soft Feel®	23
BIC® Clic Stic™ Grip	24
BIC® Clic Stic™ Ice Grip	25
BIC® Clic Stic™ Digital	26
BIC® Clic Stic™ Mini Digital	27
BIC® Tri Stic™	28
BIC® Tri Stic™ Clear	29
BIC® Vision™ Clic	30
BIC® Vision™ Clear	31
BIC® Pivo®	32
BIC® Wide Body™	33
BIC® Wide Body™ Grip	34
BIC® Wide Body™ Clear Grip	35
BIC® Wide Body™ Ice	36
BIC® Wide Body™ Digital	37
BIC® Mini Wide Body™ Digital	38
BIC® Media Max	39
BIC® Media Max Digital	40
BIC® Media Max Premium	41
BIC® Media Max Premium Digital	42
BIC® Atlantis®	43
BIC® Clic	44
BIC® Clic Gold	45
BIC® Citation™	46
BIC® Intensity® Gel Clic	47
BIC® 4 Colours & 4 Colours Pen with Lanyard	48
BIC® Grip Roller	49
BIC® Brite Liner® Grip	50
BIC® Brite Liner® Grip XL	51
BIC® Permanent Marker	52
BIC® Mark-it Permanent Marker	53
BIC® Great Erase White Board Marker	54
BIC® Matic	55
BIC® Matic Quartz	56
BIC® Matic Grip	57
BIC® Clic Matic	58
Select	
Product Name	Page
BIC® Slim Metal	66
BIC® Rondo Style	67
BIC® Wide Body™ Metal	68

BIC® Wide Body™ Metal Grip	69
BIC® Pivo® Metal	70
BIC® Protrusion Grip	71
BIC® Attriant®	72
BIC® Tri-Tone Twist	73
BIC® Steel™ Ballpen	74
BIC® Steel™ Roller	75
BIC® Steel™ Retractable	76
BIC® Rubi	77

Sheaffer®

Product Name	Page
Legacy® Heritage	80
Prelude® Black Laque	81
Prelude® Laque/Palladium cap	82
Prelude® Brushed Chrome	83
Prelude® Brushed Chrome Gold	84
Agio®	85
Sheaffer® 300	86
Sheaffer® 100	87
Sentinel®	88
Sentinel® Colors	89

Sticky Note

Product Name	Page
BIC® 50 mm x 75 mm & 68 mm x 75 mm Adhesive Notepads	92
BIC® 75 mm x 75 mm Adhesive Notepads	93
BIC® 101 mm x 75 mm Adhesive Notepads	94
BIC® 101 mm x 75 mm Alternating Sheet Imprint	95
BIC® 101 mm x 101 mm Adhesive Notepads	96
BIC® 101 mm x 152 mm Adhesive Notepads	97
BIC® 75 mm x 75 mm Adhesive Die Cut Notepads	98
BIC® 101 mm x 75 mm Adhesive Die Cut Notepads	99
BIC® 101 mm x 152 mm Adhesive Beveled Notepads	100
BIC® Flag Booklet	101
BIC® 75 mm x 75 mm Booklet	102
BIC® 101 mm x 75 mm Booklet	103
BIC® 75 mm x 75 mm Adhesive Notepads with Flag Booklet	104
BIC® 101 mm x 75 mm Mini Pencil Booklet	105
BIC® Mini Clic Stic Organizer	106
BIC® Mini Digital Clic Stic Organizer	107
BIC® 75 mm x 128 mm Non-Adhesive Scratch Pad	108
BIC® 96 mm x 152 mm Non-Adhesive Scratch Pad	109

Notebooks

Product Name	Page
BIC® Notebooks Plastic Cover	112
BIC® Notebooks Plastic Cover Fashion Colours	113
BIC® Notebooks Chipboard Cover	114
BIC® Notebooks Chipboard Cover 4- Colours	115

Lighters & Cases

Product Name	Page
BIC® J25	118
BIC® J23	119
BIC® J26	120
BIC® J39	121
BIC® J38	122
BIC® Mega Lighter	123
BIC® Gripper	124
BIC® Styl'it Fashion & Squeeze	125
BIC® C2 Metal	126
BIC® Styl'it Luxury	127

Evolutions™

Product Name	Page
BIC® Evolutions™ Round Stic™	132
BIC® Evolutions™ Media Clic	133
BIC® Evolutions™ Clic Stic™	134
BIC® Evolutions™ Clic Stic™ Digital	135
BIC® Evolutions™ Tri Stic™	136
BIC® Evolutions™ Media Clic Grip	137
BIC® Evolutions™ Media Clic Grip Digital	138
BIC® Evolutions™ Wide Body™	139
BIC® Evolutions™ Wide Body™ Digital	140
BIC® Evolutions™ Media Max	141
BIC® Evolutions™ Media Max Digital	142
BIC® Evolutions™ Clic	143
BIC® Evolutions™ Clic Gold	144
BIC® Evolutions™ Evolutions® Classic	145
BIC® Evolutions™ Evolutions® Digital	146
BIC® Evolutions™ Evolutions® Colour Connection	147
BIC® Evolutions™ Evolutions® Digital Colour Connection	148
BIC® Chipboard Notebook With Recycled Fiber	149

Combo & Special Packaging

Product Name	Page
BIC® Combo Pack	154
BIC® Packaging	155
BIC® Packaging	156
BIC® Seletc Packaging	157
BIC® Seletc Packaging	158
BIC® Sheaffer® Gift Packaging	159



Colour Table

Nuancier de couleurs / Gama de colores / Farbenindex / Tavola colori

01 white	blanc blanco weiss bianco	02 black	noir negro opak schwarz nero	03 red	rouge rojo opak rot rosso	04 blue	04 blue	bleu azul opak blau azzurro
05 green	vert verde opak grün verde	06 grey	gris gris grau grigio	07 navy	bleu azul marino opak marineblau blu	08 burgundy	08 burgundy	bordeaux burdeos burgunderrot bordeaux
10 orange	orange naranja opak orange arancio	12 yellow	jaune amarillo opak gelb giallo	13 purple	violet púrpura opak lila viola	14 pink	14 pink	rose rosa rosa rosa
18 metal	metal metal metall metallo	20 dark green	vert foncé verde oscuro opak dunkelgrün verde scuro	24 light blue	bleu clair azul claro hell blau blu chiaro	25 dark blue	25 dark blue	bleu nuit azul oscuro dunkelblau blu scuro
26 gold	or oro gold oro	27 dark grey	gris foncé gris oscuro dunkelgrau grigio scuro	29 bronzed gold	bronze oro viejo bronze bronzo	34 metallic blue	34 metallic blue	bleu métallique azul metálico metallisch blau blu metallico
35 chrome	chrome cromo premium silber cromato	39 frosted purple	violet frost púrpura frosted gefrostet lila viola frosted	40 frosted dark blue	bleu nuit frost azul oscuro frosted gefrostet dunkelblau blu frosted	46 brushed chrome	46 brushed chrome	chrome brossé cromado satinado mattiertes chrom cromo satinato
47 silver	argent plata silber argento	50 royal blue	bleu royal azul real königsblau blu royal	51 transparent	transparent transparente transparent weiss transparente	55 red lacquer	55 red lacquer	rouge laqué rojo lacado lacquer rot rosso lacquer
57 opaque white	blanc opaque blanco opaco opak weiss bianco opaco	59 apple green	vert pomme verde manzana apfelgrün verde mela	63 frosted yellow	jaune frost amarillo frosted gefrostet gelb giallo frosted	65 frosted black	65 frosted black	noir frost negro frosted gefrostet schwarz nero frosted
66 frosted red	rouge frost rojo frosted gefrostet rot rosso frosted	67 frosted blue	bleu frost azul frosted gefrostet blau azzurro frosted	68 frosted green	vert frost verde frosted gefrostet grün verde frosted	69 frosted white	69 frosted white	blanc frost blanco frosted gefrostet weiss bianco frosted
71 frosted orange	orange frost naranja frosted gefrostet orange arancio frosted	72 clear dark green	vert foncé clear verde oscuro clear transparent dunkelgrün verde scuro clear	80 clear light blue	bleu clair clear azul claro clear transparent hellblau azzurro clear	82 frosted dark green	82 frosted dark green	vert foncé frost verde oscuro frosted gefrostet dunkelgrün verde scuro frosted
83 blue pastel	bleu pastel azul pastel pastel blau azzurro pastello	84 purple pastel	violet pastel púrpura pastel pastel lila viola pastello	85 green pastel	vert pastel verde pastel pastel grün verde pastello	86 clear blue	86 clear blue	bleu clear azul clear transparent blau clear blu
87 clear red	rouge clear rojo clear transparent rot clear rosso	88 clear green	vert clear verde clear transparent grün clear verde	89 clear dark blue	bleu marine clear azul oscuro clear transparent dunkelblau clear blu	90 orange pastel	90 orange pastel	orange pastel naranja pastel pastel orange arancio pastello
91 clear black	noir clear negro clear transparent schwarz nero clear	92 clear orange	orange clear naranja clear transparent orange arancio clear	93 clear purple	violet clear púrpura clear transparent lila viola clear	4A pure silver	4A pure silver	pure silver plata silber argento
5A slate blue	slate blue azul pizarra schieferblau blu ardesia	6A artic blue	artic blue azul ártico arktisblau blu artico	7A shadow grey	shadow grey gris oscuro anthrazit grigio	8A bronze	8A bronze	bronze bronce bronze bronzo
9A champagne	champagne champagne champagner champagne	2B jungle	kaki jungla opak dschungelgrün kaki	3B frosted jungle	kaki frost jungla frosted gefrostet dschungelgrün kaki frosted	4B frosted violet	4B frosted violet	fushia frost violeta frosted gefrostet violet viola frosted

The colours shown above are for reference only. Actual colour may vary slightly depending on the product / Ces couleurs ne sont pas contractuelles, leur rendu peut varier en fonction de la matière sur laquelle elle sont apposées / Los colores arriba indicados, son sólo una referencia. El color real puede variar dependiendo del producto / Die oben angeführten Farben dienen ausschliesslich der Veranschaulichung. Leichte Abweichungen können je nach Produkt entstehen / I colori esposti sopra sono solo di riferimento. I colori reali possono essere diversi in originale a seconda del prodotto.



7,50 € ; 6,50 GBP; 72 SEK; 56 DKK; 60 NOK; 32 PLN; 11 CHF

ISO 9994 Lighters / Briquets / Encendedores / Feuerzeuge / Accendini

©2011 BIC Graphic EUROPE

Printed on paper that contains 10% recycled fiber.
Impression papier contenant 10% de fibre recyclée.
El papel utilizado en esta impresión contiene un 10% de material reciclado.
Gedruckt auf Papier, das zu 10% aus recycelten Fasern besteht.
Stampato su carta riciclata. Contiene un 10% di fibra riciclata.

www.bicgraphic.com